



miamidade.gov

**Water and Sewer**  
PO Box 330316 • 3071 SW 38 Avenue  
Miami, Florida 33233-0316  
T 305-665-7471

**VIA ELECTRONIC CORRESPONDENCE**

July 2, 2015

CCN: 59513  
File No: 8.DC.20.19

Chief, Environmental Enforcement Section  
Environment and Natural Resources Division  
U.S. Department of Justice  
P.O. Box 7611  
Ben Franklin Station  
Washington, D.C. 20044-7611  
RE: DOJ No. 90-5-1-1-4022/1  
[Walter.Benjamin.Fisherow@usdoj.gov](mailto:Walter.Benjamin.Fisherow@usdoj.gov)

Chief, Clean Water Enforcement Branch  
Water Protection Division  
Attn: Brad Ammons  
U.S. Environmental Protection Agency, Region 4  
61 Forsyth Street, S.W.  
Atlanta, Georgia 30303  
[Ammons.Brad@epa.gov](mailto:Ammons.Brad@epa.gov)

Rachael Amy Kamons  
Environmental Enforcement Section  
U.S. Department of Justice  
P.O. Box 7611  
Ben Franklin Station  
Washington, D.C. 20044-7611  
[Rachael.Kamons@usdoj.gov](mailto:Rachael.Kamons@usdoj.gov)

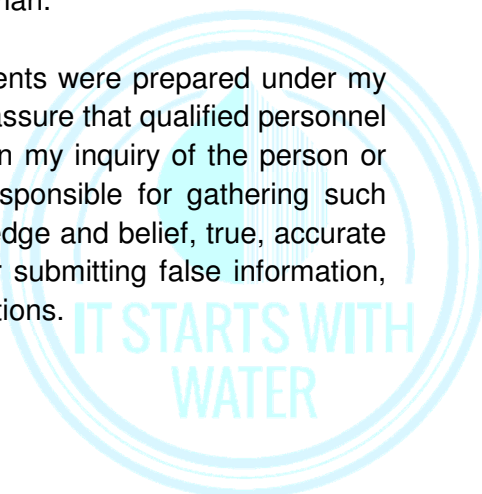
Florida Department of Environmental Protection  
Southeast District – Suite 200  
400 N. Congress Ave.  
West Palm Beach, FL 33401  
Attn: Compliance/Enforcement Section  
[Diane.Pupa@dep.state.fl.us](mailto:Diane.Pupa@dep.state.fl.us)

**RE: Consent Decree (Case: No. 1:12-cv-24400-FAM)**  
**Reference DOJ Case No. 90-5-1-1-4022/1**  
**Section VI – Sewer Overflow Response Plan Submittal, Paragraph 19(b)**

Dear Sir/Madam:

In accordance with the provisions of Paragraph 19(b) of the above referenced Consent Decree, on behalf of Miami-Dade County, the Miami-Dade Water and Sewer Department (MDWASD) submits to the Environmental Protection Agency (EPA) and the State of Florida Department of Environmental Protection (FDEP) the Sewer Overflow Response Plan.

I certify under penalty of law that this document and all attachments were prepared under my direction or supervision in accordance with a system designed to assure that qualified personnel properly gather and evaluate the information submitted. Based on my inquiry of the person or persons who manage the system, or those persons directly responsible for gathering such information, the information submitted is, to the best of my knowledge and belief, true, accurate and complete. I am aware that there are significant penalties for submitting false information, including the possibility of fine and imprisonment for knowing violations.



Should you have any questions regarding this matter, please call me at (786) 552-8571.

Sincerely,



Juan Carlos Arteaga, AIA, NCARB, CBO, APA, LEED® AP  
Deputy Director for Regulatory Compliance & Capital Improvements

Attachments: Sewer Overflow Response Plan

ec: Jonathan A. Glogau  
Special Counsel  
Chief, Complex Litigation  
Office of the Attorney General  
PL-01, The Capitol  
Tallahassee, FL 32399-1050  
850-414-3817  
[Jon.Glogau@myfloridalegal.com](mailto:Jon.Glogau@myfloridalegal.com)

Florida Department of Environmental Protection  
Southeast District – Suite 200  
400 N. Congress Ave.  
West Palm Beach, FL 33401  
Attn: Compliance/Enforcement Section  
[Linda.Brien@dep.state.fl.us](mailto:Linda.Brien@dep.state.fl.us)  
[Lisa.M.Self@dep.state.fl.us](mailto:Lisa.M.Self@dep.state.fl.us)  
[Sed.wastewater@dep.state.fl.us](mailto:Sed.wastewater@dep.state.fl.us)

Mayor Carlos A. Gimenez  
Miami-Dade County  
111 NW First Street 29<sup>th</sup> Floor  
Miami, Florida 33128

Lester Sola, Director  
Miami-Dade Water and Sewer Department  
3071 SW 38<sup>th</sup> Avenue  
Miami, Florida 33146

Jack Osterholt, Deputy Mayor/Director  
Miami-Dade Regulatory and  
Economic Resources  
111 NW 1st Street, 29th Floor  
Miami, FL 33128  
[Josterholt@miamidade.gov](mailto:Josterholt@miamidade.gov)

Robert A. Cuevas, Jr.  
Miami-Dade County Attorney  
111 NW First Street Suite 2810  
Miami, Florida 33128

William Bush  
Associate Regional Counsel  
U.S. EPA, Region 4  
61 Forsyth Street, SW  
Atlanta, Georgia 30303  
[Bush.William@epa.gov](mailto:Bush.William@epa.gov)

William A. Weinischke  
Senior Trial Attorney  
Environmental Enforcement Section  
Environment and Natural Resources Division  
U.S. Department of Justice  
P.O. Box 7611  
Washington, D.C. 20044  
[Bill.Weinischke@usdoj.gov](mailto:Bill.Weinischke@usdoj.gov)

ebc: Douglas L. Yoder  
Eduardo Vega  
Bertha Goldenberg  
Henry Gillman  
Frances G. Morris  
Sarah Davis  
Sherry Negahban  
Richard O'Rourke  
Howard Fallon  
Robert Fergen  
Al Galambos  
Rod Lovett  
Manuel Moncholi  
Dan Edwards  
Rolando Roque  
Juan Bedoya  
Vincent Flick  
Lee N. Hefty (RER-DERM)  
Carlos Hernandez (RER-DERM)  
Rashid Istambouli (RER-DERM)  
David Haywood (CD PMCM)  
Abby Diaz (CD PMCM)  
Cynthia Doyon (CD PMCM)

# CMOM Program Sewer Overflow Response Plan



July 2, 2015

Prepared by

**The Miami-Dade Water and Sewer Department and  
the Consent Decree CMOM Program Team**

Prepared for

United States Environmental Protection Agency and  
Florida Department of Environmental Protection

THIS PAGE LEFT INTENTIONALLY BLANK

## Sewer Overflow Response Plan

**PREPARED FOR:**

**Miami-Dade Water and Sewer Department (MDWASD)**

**PREPARED BY:**

THE CONSENT DECREE CMOM PROGRAM TEAM  
10900 NW 25<sup>TH</sup> STREET, SUITE 100  
MIAMI, FL 33172

The information contained in this document is solely for the use of the client identified on the cover sheet, and for the purposes specified herein. Woolpert, Inc. undertakes no duty and accepts no responsibility to any third party that may rely on this document.

All rights reserved. No section or element of this document may be removed from this document, reproduced, electronically stored, or transmitted in any form without the written permission of the CD CMOM Program Team.


## Quality Information

**Status: Final**

Document	Sewer Overflow Response Plan		
Ref	Date	July 2, 2015	
Prepared by	Jane McLamarrah, PhD, PE	Reviewed by	Flint Holbrook, PE

### Revision History

Authorized by:

Revision	Revision Date	Status	Revised by:	Name/Position	Signature
0.0	July 2, 2015	DraftFinal	Jane McLamarrah, PhD, PE	Luis Casado William Sukenik, PE, PMP	

THIS PAGE LEFT INTENTIONALLY BLANK



## Table of Contents

<b>List of Tables</b> .....	<b>vii</b>
<b>List of Figures</b> .....	<b>vii</b>
<b>00. Acronyms / Glossary</b> .....	<b>00-1</b>
00.01 Acronyms / Abbreviations .....	00-1
00.02 Glossary .....	00-3
<b>01. Introduction</b> .....	<b>01-1</b>
01.01 Summary of the Sewer System.....	01-1
01.02 Regulatory Drivers .....	01-1
01.03 Miami-Dade County Organization .....	01-6
01.03.1 Water and Sewer Department Organization .....	01-6
01.03.2 Regulatory and Economic Resources Department .....	01-8
01.04 SORP Document Organization .....	01-10
<b>02. SORP Purpose and Goals</b> .....	<b>02-1</b>
02.01 SORP Purpose .....	02-1
02.02 SORP Goals .....	02-1
<b>03. Phased SORP Development</b> .....	<b>03-1</b>
03.01 SORP Plan Review and Revision .....	03-1
03.02 Planned Supportive Actions .....	03-2
03.02.1 Phased Implementation Actions .....	03-2
03.02.2 Implementation Schedule .....	03-2
<b>04. SORP Performance Measures</b> .....	<b>04-1</b>
04.01 Purpose of Performance Measures.....	04-1
04.02 Established Performance Measures.....	04-1
04.03 Performance Metric Reviews and Revisions .....	04-2
<b>05. SSO Reporting and Notifications</b> .....	<b>05-1</b>
05.01 SSO Reporting Requirements.....	05-1
05.02 SSO Identification .....	05-3
05.03 SSO Notifications.....	05-6
05.03.1 Immediate 24-Hour Notifications.....	05-7
05.03.2 5-Day Written Reports .....	05-10
05.03.3 Repeat SSOs .....	05-11
05.03.4 Building Backups .....	05-12
05.04 Document Retention .....	05-14
<b>06. SSO and Building Backup Response</b> .....	<b>06-1</b>
06.01 Emergency Response Protocols .....	06-2
06.01.1 SSO Emergency Response Protocols .....	06-2
06.01.2 Building Backup Emergency Response Protocols .....	06-7
06.02 SSO Control.....	06-8
06.02.1 Flow Diversion and Environmental Precautions .....	06-8
06.02.2 Wastewater Pipes.....	06-11
06.02.3 Pump Stations .....	06-11

06.02.4	Treatment Plants .....	06-14
06.03	Cleanup Procedures .....	06-21
06.03.1	SSO Cleanup .....	06-22
06.03.2	Building Backup Cleanup.....	06-23
06.04	Water Quality Monitoring.....	06-24
06.04.1	Sample Parameters.....	06-25
06.04.2	Schedule .....	06-25
06.04.3	Initial “Day One” Sampling.....	06-25
06.04.4	“Day Two” Sampling .....	06-26
06.04.5	Continued Sampling .....	06-26
06.05	Water Quality Analysis.....	06-26
06.05.1	Quality Assurance .....	06-26
06.05.2	Field Parameters .....	06-27
06.05.3	Laboratory Analyses.....	06-27
06.05.4	Laboratory Results and Reporting .....	06-27
06.05.5	Field Sampling Results.....	06-28
06.06	Follow Up Measures .....	06-28
06.06.1	SSO Volume Estimations .....	06-28
06.06.2	Cause Determination.....	06-30
06.06.3	Follow Up Corrective Actions.....	06-30
<b>07.</b>	<b>SSO Response Preparedness .....</b>	<b>07-1</b>
07.01	Staffing and Resources.....	07-1
07.02	Preparedness Training.....	07-3
<b>08.</b>	<b>SSO Prevention .....</b>	<b>08-1</b>
08.01	SSO Predictive Techniques .....	08-1
08.02	Root Cause Analysis.....	08-2
08.03	Preventative Strategies.....	08-7
08.03.1	FOG-Related SSO Prevention.....	08-7
08.03.2	Force Main Break-Related SSO Prevention.....	08-8
08.03.3	Air Release Valve-Related SSO Prevention .....	08-10
08.03.4	Pump Station-Related SSO Prevention .....	08-10
08.03.5	Capacity-Related SSO Prevention.....	08-11
08.03.6	Building Backup Prevention.....	08-12
<b>09.</b>	<b>Climate Change Impacts .....</b>	<b>09-1</b>
09.01	SORP Vulnerabilities .....	09-1
09.02	Climate Change Predictions.....	09-2
<b>10.</b>	<b>Appendices .....</b>	<b>10-1</b>

## Appendices

APPENDIX A	Example Domestic Wastewater Discharge/Abnormal Event Notification
APPENDIX B	Example Building Backup Event Notification
APPENDIX C	Verbal and Electronic Notification Flow Chart
APPENDIX D	Repeat SSO List for Period Ending March 30, 2015
APPENDIX E	Pump Station Upstream Low Manhole List
APPENDIX F	Sewage Backup Prevention Fact Sheet
APPENDIX G	Orifice Tables for SSO Discharge Volume Calculations

## List of Tables

Table 00.1	Abbreviations Used in the SORP	00-1
Table 01.1	Location of CD Requirements in the SORP	01-10
Table 03.1	Proposed SORP Phased Implementation Activities	03-4
Table 04.1	Key SORP Performance Indicators	04-2
Table 06.1	Emergency Response Plan Element Overview and Staff Responsibility	06-1
Table 06.2	Agency Contacts for Emergency Response Permitting/Authorization	06-10
Table 07.1	Recommended Staffing Additions for SORP-Related Activities	07-2
Table 09.1	Saffir-Simpson Hurricane Wind Scale	09-3
Table 09.2	Recommended Planning Horizon Based On Asset Life	09-4

## List of Figures

Figure 01.1	MDWASD Wastewater Treatment Plants and Service Areas	01-2
Figure 01.2	MDWASD Organization Chart	01-7
Figure 01.3	RER-DERM Organization Chart	01-9
Figure 05.1	Incident Identification Flow Chart	05-4
Figure 05.2	SSO Investigation Flow Chart	05-5
Figure 05.3	Building Backup Investigation Flow Chart	05-5
Figure 05.4	SSO Notification Overview Flow Chart	05-6
Figure 05.5	MDWASD Lateral Maintenance Protocol Diagram	05-14
Figure 06.1	Gravity Main SSO Field Response	06-5
Figure 06.2	Force Main SSO Field Response	06-5
Figure 06.3	Air Relief Valve SSO Field Response	06-6
Figure 06.4	Pump Station SSO Field Response	06-6
Figure 06.5	Wastewater Pump Station Bypass Schematic	06-13
Figure 06.6	NDWWTP Bypass Scheme	06-16
Figure 06.7	CDWWTP Bypass Scheme	06-17
Figure 06.8	SDWWTP Bypass Scheme	06-18
Figure 06.9	Inter-District Flow Diversion Network	06-19
Figure 06.10	Flow Control at Pump Station 187	06-20
Figure 08.1	FOG-Related SSO Immediate Prevention	08-1

Figure 08.2 Illegal Discharge-Related SSO Immediate Prevention..... 08-2  
Figure 08.3 Pipe Defect-Related SSO Immediate Prevention ..... 08-2  
Figure 08.4 Insufficient Grade-Related SSO Immediate Prevention ..... 08-2  
Figure 08.5 Critical Location or Recurring SSO Immediate Prevention ..... 08-2  
Figure 08.6 Gravity Main Root Cause Analysis Flow Chart ..... 08-4  
Figure 08.7 Force Main Root Cause Analysis Flow Chart ..... 08-5  
Figure 08.8 Air Relief Valve Root Cause Analysis Flow Chart..... 08-6  
Figure 09.1 WWTP and Pump Station Generic Service Life Schematic ..... 09-4

## 00. Acronyms / Glossary

### 00.01 Acronyms / Abbreviations

<i>Table 00.1 Abbreviations Used in the SORP</i>	
<b>Abbreviation</b>	<b>Description</b>
AP TTC	Adequate Pumping Transmission & Treatment Capacity Program
AMS	Asset Management System
AASIS	Active As-built Supplemental Information System
BFE	Base Flood Elevation
CCTV	Closed Circuit Television
CD	Consent Decree
CD PMCM Team	Consent Decree Program Management and Construction Management Team
CMOM	Capacity, Management, Operations, and Maintenance
County	Miami-Dade County
CWA	Clean Water Act
DFE	Design Flood Elevation
DOH	Miami-Dade County Department of Health
EAMS	Enterprise Asset Management System
EDMS	Electronic Document Management System
F.A.C.	Florida Administrative Code
FDEP	Florida Department of Environmental Protection
FEMA	Federal Emergency Management Agency
FIC	Field Investigation Crew
FOG	Fats, Oils, and Grease
FP&L	Florida Power and Light
FMOPMARP	Force Main Operations, Preventative Maintenance, and Assessment / Rehabilitation Program
GPD	Gallons Per Day
GIS	Geographic Information Systems
GPS	Global Positioning System
GSS	Gravity Sewer System
GSSOMP	Gravity Sewer System Operations and Maintenance Program
IMS	Information Management System
IS	Information Systems
IT	Information Technology
KPI	Key Performance Indicator
LOS	Level of Service
MDOC	Miami-Dade Office of Communications

**Table 00.1**  
**Abbreviations Used in the SORP**

Abbreviation	Description
MDWASD	Miami-Dade County Water and Sewer Department
MGD	Million Gallons Per Day
MOM	Management, Operations, and Maintenance
NEMA	National Electrical Manufacturers Association
NFPA	National Fire Protection Agency
NPDES	National Pollutant Discharge Elimination System
O&M	Operations and Maintenance
OOL	Ocean Outfall Legislation
OPP	Overflow Prevention Plan
OSHA	Occupational Safety and Health Administration
PdM	Predictive Maintenance
PM	Preventative Maintenance
PD	Program Director, MDWASD Director or Delegate
Program	Consent Decree Program
PSD	Pump Station Division
PSIP	Pump Station Improvement Program
PSOPMP	Pump Station Operations and Preventative Maintenance Program
QA/QC	Quality Assurance/Quality Control
R&R	Rehabilitation and Repair
RAP	Remedial Action Plan
RER-DERM	Miami-Dade County Department of Regulatory and Economic Resources – Division of Environmental Resources Management
RCA	Root Cause Analysis
RM	Routine Maintenance
SCADA	Supervisory Control and Data Acquisition
SFWMD	South Florida Water Management District
SOP	Standard Operating Procedure
SORP	Sewer Overflow Response Plan
SSAMP	Sewer System Asset Management Program
SPP	Spare Parts Program
SSES	Sanitary Sewer Evaluation Survey
SSO	Sanitary Sewer Overflow
USACE	U.S. Army Corps of Engineers
WWCTLD	MDWASD Wastewater Collection and Transmission Line Division
WCTS	Wastewater Collection and Transmission System
WMD	Water Management District
WQIC	Water Quality Impact Committee

**Table 00.1**  
**Abbreviations Used in the SORP**

Abbreviation	Description
WWTMD	Wastewater Treatment and Maintenance Division
WWTP	Wastewater Treatment Plant
WWTP OMP	Wastewater Treatment Plant Operations and Maintenance Plan
VSC	Volume Sewer Customer
VSCO	Volume Sewer Customer Ordinance

## 00.02 Glossary

**Building Backup:** A wastewater release or backup into a building or private property that is caused by blockages, flow conditions, or other malfunctions in Miami-Dade’s wastewater collection and transmission system (WCTS) and which is considered a Sanitary Sewer Overflow under the Consent Decree. A wastewater backup or release that is caused by blockages, flow conditions, or other malfunctions of a Private Lateral or internal building plumbing is a Private Building Backup, not a Public Building Backup, and is not considered a Sanitary Sewer Overflow.

**Capacity, Management, Operations, and Maintenance (CMOM):** A program of accepted industry practices to properly manage, operate, and maintain sanitary wastewater collection, transmission, and treatment systems, investigate capacity constrained areas of these systems, and respond to sanitary sewer overflow (SSO) events.

**Closed-circuit Television (CCTV):** Technology by which Miami-Dade inspection crews and/or its outside contractors use a video camera to visually inspect the internal condition of pipes and sub-surface structures.

**Consent Decree (CD):** The Consent Decree, Case: 1:12-cv-24400-FAM, entered between Miami-Dade County, Florida (Defendant), the State of Florida, the Florida Department of Environmental Protection, and the U.S. Environmental Protection Agency (Plaintiffs).

**Consent Decree Program Management and Construction Management Team (CD PMCM):** The professional services consulting team competitively selected by the County to support MDWASD in the implementation of the requirements of the CD.

**Environmental Protection Agency (EPA):** United States Environmental Protection Agency and any of its successor departments or agencies.

**Fats, Oils, and Grease (FOG) Control Program:** “FOG” refers to fats, oils, and grease, which are generated by residents and businesses processing or serving food and other products. A FOG Control Program aims to prevent FOG accumulation in sewer systems.

**Florida Department of Environmental Protection:** State of Florida Department of Environmental Protection and any of its successor departments or agencies.

**Force Mains:** Any pipe that receives and conveys, under pressure, wastewater from the discharge side of a pump. A force main is intended to convey wastewater under pressure.

**Geographic Information System (GIS):** A system consisting of hardware, software, and data that is designed to capture, store, and analyze geographically-referenced information.

**Gravity Sewer Line or Gravity Sewer:** Pipes that receive, contain, and convey wastewater not normally under pressure, but are intended to flow unassisted under the influence of gravity.

**Gravity Sewer System Operations and Maintenance Program (GSSOMP):** The Consent Decree stipulated CMOM deliverable that sets forth the protocols and procedures associated with the operations and maintenance of the gravity sewer system.

**Infiltration:** As defined by 40 CFR § 35.2005(b)(20) shall mean water other than wastewater that enters the WCTS (including sewer service connections and foundation drains) from the ground through such means as defective pipe, pipe joints, connections, or manholes.

**Inflow:** As defined by 40 CFR § 35.2005(b)(21) shall mean water other than wastewater that enters the WCTS (including sewer service connections) from sources such as, but not limited to, roof leaders, cellar drains, yard drains, area drains, drains from springs and swampy areas, manhole covers, cross connections between storm sewers and sanitary sewers, catch basins, cooling towers, storm water, surface runoff, street wash waters, or drainage.



**Infiltration and Inflow (I/I):** The total quantity of water from inflow, infiltration, and rainfall-induced infiltration and inflow without distinguishing the source.

**Lift Station:** A facility in the WCTS (not at the wastewater treatment plants) comprised of pumps which lift wastewater to a higher hydraulic elevation, including related electrical, mechanical, and structural systems necessary to the operation of the lift station (referenced in this document as pump station). As defined in MDWASD's 1996 O&M Manual, lift stations discharge to a downstream gravity main.

**Manhole or Junction Box:** Part of the gravity sewer system. A structure that provides a connection point for gravity lines, private service laterals, or force mains, as well as an access point for maintenance and repair activities.

**Miami-Dade:** Miami-Dade County, Florida, including all of its departments, agencies, instrumentalities such as the Water and Sewer Department and the Department of Regulatory and Economic Resources, and any successors thereto.

**NPDES:** The National Pollutant Discharge Elimination System (NPDES) authorized under Section 403 of the Clean Water Act (CWA).

**Nominal Average Pump Operating Time (NAPOT):** The NAPOT is defined as the daily average total pump operating hours for the previous twelve months divided by one less than the total number of pumps installed in the station. The criteria from the First Partial Consent Decree and the Second and Final Partial Consent Decree requires that each pump station operate at a nominal average pump operating time of less than or equal to 10 hours per day, or the equivalent based on power usage, with exceedances of the criteria requiring a Remedial Action Plan and no building permits issued for connection to the WCTS upstream of that station. The NAPOT requirement is currently part of the local Volume Sewer Customer Ordinance (VSCO).

**Private Lateral:** The portion of a sanitary sewer conveyance pipe that extends from a single-family, multifamily, apartment or other dwelling unit, or commercial or industrial structure to which wastewater service is or has been provided up to the property line of such structure or to a public sewer in a proper easement.

**Prohibited Bypass:** The intentional diversion of waste streams from any portion of a treatment facility which is prohibited pursuant to the terms set forth at 40 CFR § 122.41(m).

**Public Document Repository (PDR):** The Miami-Dade Water and Sewer Department (MDWASD) is required to make a copy of CD designated deliverables available within one business day from the submission of the deliverable to EPA/FDEP in a PDR. MDWASD's PDR is located at 3071 SW 38<sup>th</sup> Ave and the Miami-Dade Water and Sewer Department's website, <http://www.miamidade.gov/water>.

**Public Lateral:** The portion of a sanitary sewer conveyance pipe that extends from the private lateral, which typically has a cleanout located at the property line or at the easement line, to the sewer main.

**Pump Station:** A facility in the WCTS (not at the WWTPs) comprised of pumps which transport wastewater from one location to another location, including all related electrical, mechanical, and structural systems necessary to that pump station. As defined in MDWASD's 1996 O&M Manual, pump stations discharge to a force main, to a booster station, or to a WWTP.

**Pump Station Operations and Preventative Maintenance Program (PSOPMP):** The Consent Decree stipulated CMOM deliverable that sets forth the protocols and procedures associated with the operations and maintenance of the sewer pump station system.

**Repeat SSO:** Any SSO event that recurs at the same point within a 12-month period.

**Sanitary Sewer Overflow (SSO):** Any discharge of wastewater to waters of the United States or the State from Miami-Dade's WCTS through a point source not permitted in any NPDES permit, as well as any overflow, spill, or release of wastewater to public or private property from the WCTS that may or may not have reached waters of the United States or the State, including building backups. A wastewater overflow, backup, or release that is caused by blockages, flow conditions, or other malfunctions of a Private Lateral or internal building plumbing is not a SSO. MDWASD refers to SSOs that are large (roughly 50,000 gallons or more), on-going, or endanger public health or the environment as "major spills," with the Water Quality Impact

Committee (WQIC) making the determination as a group as to which spills are considered major spills requiring public notifications.

**Sewer Overflow Response Plan (SORP):** The SORP provides structured guidance, including a range of field activities to choose from, for a generalized uniform response to overflows, backups, or releases.

**Sewer System:** The Wastewater Collection and Transmission System (WCTS) and the Wastewater Treatment Plants (WWTPs).

**Supervisory Control and Data Acquisition (SCADA) System:** A system of automated sensory control equipment that monitors the operation of a portion of the lift stations (or pump stations) within the collection system. The SCADA system is designed to convey alarms when predetermined conditions occur. Monitoring parameters may include, but are not limited to, power failures, high wet well levels, pump failures that could potentially cause overflows, excessive pump runtimes, or other alarm set points as may be determined by system operators.

**Wastewater Collection and Transmission System (WCTS):** The municipal wastewater collection, and transmission system, including all pipes, force mains, gravity sewer lines, pump stations, manholes, and appurtenances thereto, which are owned or operated by Miami-Dade Water and Sewer Department designed to collect and convey municipal sewage (domestic, commercial, and industrial) to Miami-Dade's WWTPs.

**Wastewater Treatment Plant (WWTP):** Devices or systems used in the storage, treatment, recycling, and reclamation of municipal wastewater and include all facilities owned, managed, operated, and maintained by Miami-Dade Water and Sewer Department, including but not limited to the North District WWTP, the Central District WWTP, and the South District WWTP, and all components of those plants.

**WWTP Operations and Maintenance Program (WWTP OMP):** The Consent Decree stipulated CMOM deliverable that sets forth the protocols and procedures associated with the operations and maintenance of the wastewater treatment plants.

THIS PAGE LEFT INTENTIONALLY BLANK

## 01. Introduction

The Miami-Dade Water and Sewer Department (MDWASD) prepared this Sewer Overflow Response Plan (SORP) plan in compliance with Paragraph 19(b) of the Consent Decree (CD) between Miami-Dade County (County) and the plaintiffs, the United States of America, the State of Florida (State), and the Florida Department of Environmental Protection (FDEP), adjudicated by the United States District Court for the Southern District of Florida in Case No. 1:12-cv-24400-FAM. The CD requires the County to develop, submit, finalize, and implement plans for the continued improvement of its wastewater collection and transmission system (WCTS) and wastewater treatment plants (WWTPs) to eliminate, reduce, prevent, or otherwise control sanitary sewer overflows (SSOs).

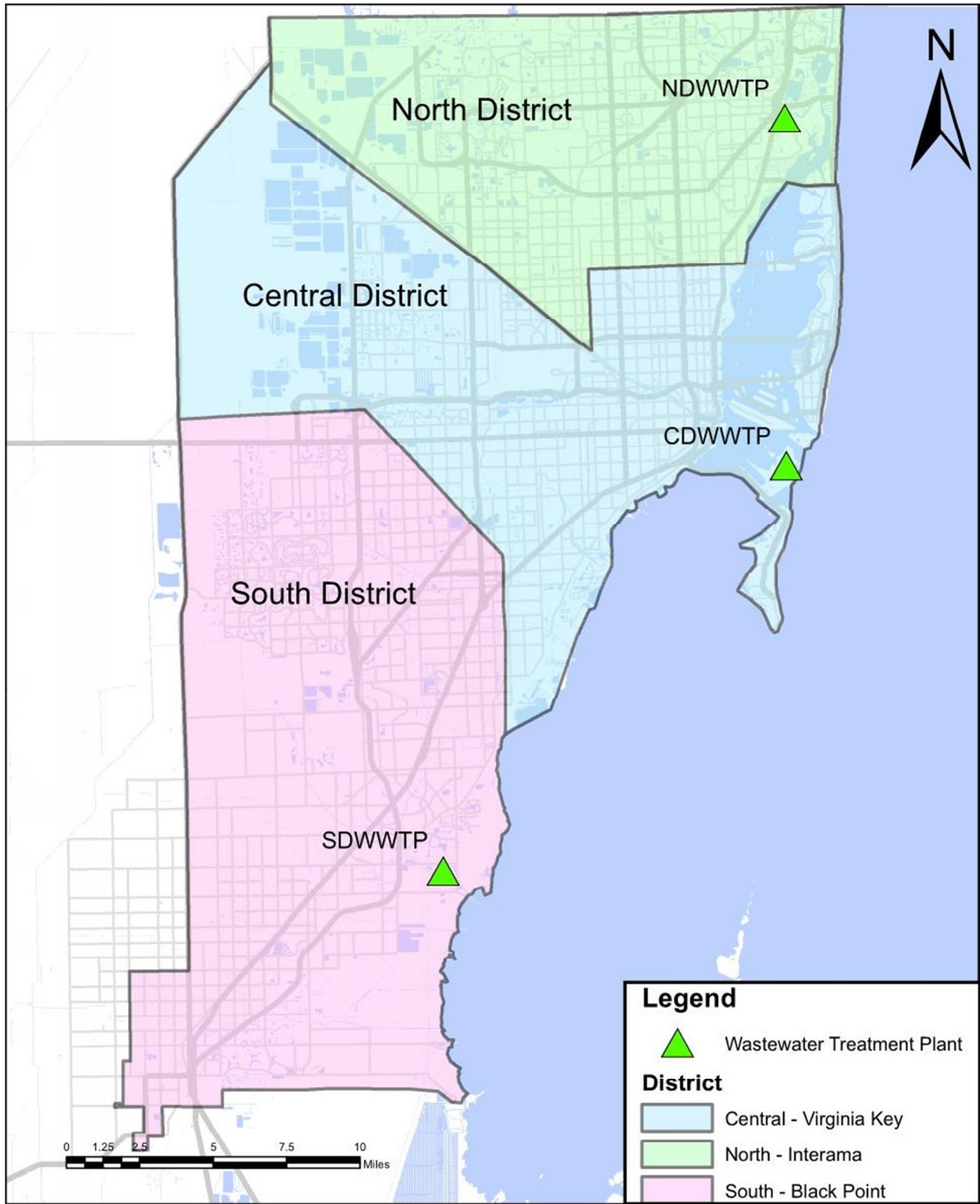
### 01.01 Summary of the Sewer System

As of February 1, 2015, MDWASD's WCTS consists of approximately 6,300 miles of pipelines, 1,028 MDWASD pump stations, 19 pump stations maintained under maintenance agreement with other agencies and departments. The WCTS conveys wastewater to three WWTPs. In addition, there are numerous private pump stations and private collection systems discharging wastewater into MDWASD's WCTS. The numbers cited herein, especially the number of pump stations, are subject to change due to additions and abandonments in a dynamic, urban service area such as Miami-Dade County. The current service area boundaries tributary to each of the three treatment plants are shown on Figure 01.1 on the following page.

### 01.02 Regulatory Drivers

Compliance with the requirements of the Clean Water Act (CWA) is the primary regulatory driver for the SORP. The County entered into the CD in response to violations of the CWA, which consisted of unpermitted discharges of untreated sanitary sewage into waters of the United States from the WCTS and which are referred to as SSOs.

**Figure 01.1**  
**MDWASD Wastewater Treatment Plants and Service Areas**



Under the terms of the CD, a wastewater release or backup into a building or private property that is caused by blockages, flow conditions, or other malfunctions in Miami-Dade's WCTS is also considered an SSO event. As noted in Subsection 00.02, Glossary, these events are referred to as Building Backups. Building backups that are caused by blockages, flow conditions, or other malfunctions of a private lateral or internal building plumbing are not considered an SSO under the CD.

To support realization of the goal of reducing, preventing, or otherwise controlling SSOs and prohibited discharges to waters of the United States, the CD, Paragraph 18, requires MDWASD to continue programs initiated under previous CDs, and Paragraph 19 stipulates the development of CMOM programs across all areas of the wastewater, collection, transmission, and treatment systems, including: pump stations, force mains, gravity sewers, and wastewater treatment plants. CD Paragraph 18 "existing" CMOM programs and Paragraph 19 "new" CMOM programs are listed below. The CD Programs listed in ***bold italics*** have direct impact on elements and requirements of the SORP.

1. 18(a) Adequate Pumping, Transmission, and Treatment Capacity (APTTC) Program;
2. ***18(b) Pump Station Remote Monitoring (PSRM) Program;***
3. ***18(c) WCTS Model;***
4. ***18(d) Spare Parts Program (SPP);***
5. 18(e) Volume Sewer Customer Ordinance (VSCO) Program;
6. ***19(a) Fats, Oils, and Grease (FOG) Control Program;***
7. ***19(c) Information Management System (IMS) Program;***
8. 19(d) Sewer System Asset Management Program (SSAMP);
9. ***19(e) Gravity Sewer System Operations and Maintenance Program (GSSOMP);***
10. ***19(f) Pump Station Operations and Preventative Maintenance Program (PSOPMP);***
11. ***19(g) Force Main Operations, Preventative Maintenance, and Assessment / Rehabilitation Program (FMOPMARP);***
12. 19(h) WWTP Operations and Maintenance Program (WWTP OMP);

13. 19(i) Specific Capital Improvements Projects (CIP); and

14. 19(j) Financial Analysis Program.

The sub-paragraphs of 19(b) require MDWASD to “establish timely and effective methods and means of responding to, cleaning up, and/or minimizing the impact of SSOs; timely reporting of the location, volume, cause, impact, and other pertinent SSO information to the appropriate regulatory authorities; and timely and effective notification of SSOs to potentially impacted public.” The SORP must include the following:

- Paragraph 19(b)(i). Provide an oral report within 24 hours to FDEP through the State Warning Point Hotline of the location of any SSO entering waters of the United States or the State, any SSO greater than or equal to 1,000 gallons, or any SSO that will endanger public health or the environment;
- Paragraph 19(b)(ii). Provide a written report within 5 days to FDEP of the location of any SSO entering waters of the United States or the State, any SSO greater than or equal to 1,000 gallons, or any SSO that will endanger public health or the environment, including the following information;
  - SSO location by street address or other appropriate method,
  - Estimated time and date for the start and stop of the SSO (or the anticipated stop time if still active),
  - Steps taken to respond to the SSO,
  - Name of the receiving water, if applicable,
  - Estimated volume (in gallons) of sewage spilled,
  - Description of the WCTS component from which the SSO was released,
  - Estimate of the SSO’s impact on public health and to water quality subject to available information,
  - Cause, or suspected cause, of the SSO,
  - Date of the last SSO at the same point,
  - Steps taken to reduce, prevent, or eliminate reoccurrence of the SSO,
  - List of notifications to the public or other agencies or departments, and
  - Steps taken, or to be taken, to cleanup contaminated surfaces.



- Paragraph 19(b)(iii). Maintain all records documenting the steps taken, and which will be taken, to prevent the SSO recurrence for a period of not less than 5 years;
- Paragraph 19(b)(iv). Provide procedures for responding to all SSOs to minimize the environmental impact and potential human health risk of SSOs, including:
  - Detailed description of actions to provide public notice,
  - Detailed description of actions to provide appropriate federal, state, or local agency/authority notice,
  - Detailed plan and response Standard Operating Procedures (SOPs) to minimize the volume of untreated wastewater transmitted to the portion of the WCTS impacted by the events precipitating the SSO to minimize overflow volumes,
  - Particular description of response to Building Backups, including:
    - Timeframe for responses,
    - Cleanup measures,
    - Disinfection/removal procedures for contaminated items, and
    - Follow up process to ensure adequacy of cleanup.
- Paragraph 19(b)(v). Detailed plan of resources to be used to correct or repair the condition causing or contributing to the SSO;
- Paragraph 19(b)(vi). Detailed plan to ensure preparedness, including:
  - Response training and
  - SSO volume estimation training.
- Paragraph 19(b)(vii). Listing of SSO locations within the WCTS served by each pump station that have been recorded as overflowing more than once within the previous 12-month period and/or those locations at which an SSO is likely to occur in the event of a pump station failure; and
- Paragraph 19(b)(viii). Pump station emergency bypass/pump-around strategies and procedures.

In addition to the specific requirements of Paragraph 19, the CD references specific guidance tools that support the incorporation of industry CMOM “best-practices” in municipal wastewater utility operations. Industry CMOM best-practices are those core WCTS management attributes commonly found in highly performing utilities and often include adoption of asset and life-cycle-

cost management concepts through implementation of preventative and predictive management policies and procedures. Reductions in emergency maintenance and repair activities leading to reductions in SSOs demonstrate the effectiveness of these best-practices. The CD requires concurrent development and implementation of 15 separate management programs (i.e., the 14 listed above plus this SORP). The programs' inherent interdependencies require an interdisciplinary and integrated approach to wastewater system management, operations, and management.

## 01.03 Miami-Dade County Organization

The County operates under Home-Rule Authority granted by the Florida State Constitution. The unincorporated areas of Miami-Dade County are governed by the 13-member Board of County Commissioners (Commission). The County government provides major metropolitan services countywide and city-type services for residents of the unincorporated areas. Miami-Dade County has a Mayor who oversees the day-to-day operations of the County. The County is organized into multiple Departments, each led by a Mayor-appointed Director.

### 01.03.1 Water and Sewer Department Organization

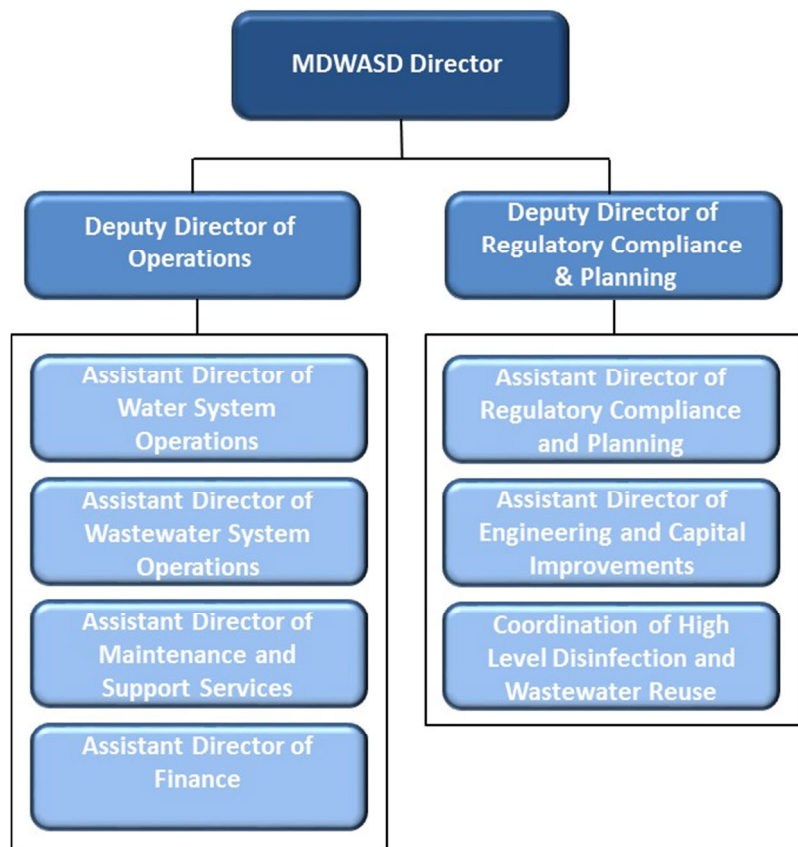
As shown in Figure 01.2 on the following page, two Deputy Directors manage the MDWASD under the authority of the Director: the Deputy Director of Operations and the Deputy Director of Regulatory Compliance and Capital Improvements. There are four Assistant Directors under the Deputy Director of Operations, in addition to the Security Office which is not shown on the figure. There are two Assistant Directors and a special projects coordinator under the Deputy Director of Regulatory Compliance and Capital Improvements. SORP response activities are under the Assistant Director of Wastewater System Operations and SORP reporting activities are under the Assistant Director of Regulatory Compliance and Planning.

The Wastewater Collection and Transmission Line Division (WWCTLD) has the primary responsibility to respond to SSO events relating to gravity sewer and force main assets. The Pump Station Division (PSD) has the primary responsibility to respond to SSO events relating to pump station assets. The Wastewater Treatment and Maintenance Division (WWTMD) has

primary responsibility to respond to SSOs related to treatment plant influent pump station transmission system assets.

Other instances of noncompliance at the WWTPs are required to be reported under the “General Conditions” section of the National Pollutant Discharge Elimination System (NPDES) permit for that plant. Noncompliance events include bypasses, plant upsets (that cause violations), violations of maximum daily limits, and unauthorized discharges. These events are required to be reported orally within 24 hours with written reports following within 5 days. The unauthorized discharges include “spills” of partially treated sewage. Spills exceeding 1,000 gallons or which endanger public health or the environment must be reported within the 24-hour oral report requirement. Spills less than 1,000 gallons that were not reported must be included in the plant’s Discharge Monitoring Report (DMR). SSOs at the influent facilities are covered under this SORP. Spills of partially treated sewage are covered under the Wastewater Treatment Plant Operations and Maintenance Program (WWTP OMP).

**Figure 01.2**  
**MDWASD Organization Chart**



### 01.03.2 Regulatory and Economic Resources Department

The Miami-Dade County Department of Regulatory and Economic Resources – Division of Environmental Resource Management (RER-DERM) provides services to protect, enhance, and restore environmental resources in the County. One of the RER-DERM roles relating to wastewater infrastructure is to act as the local delegated authority for implementation of the Domestic Wastewater Permitting Programs under FDEP guidelines. These delegated authorities are part of the FDEP/DERM Specific Operating Agreement reached by FDEP and DERM (now RER-DERM) on January 21, 2001, effective as of April 17, 2001.

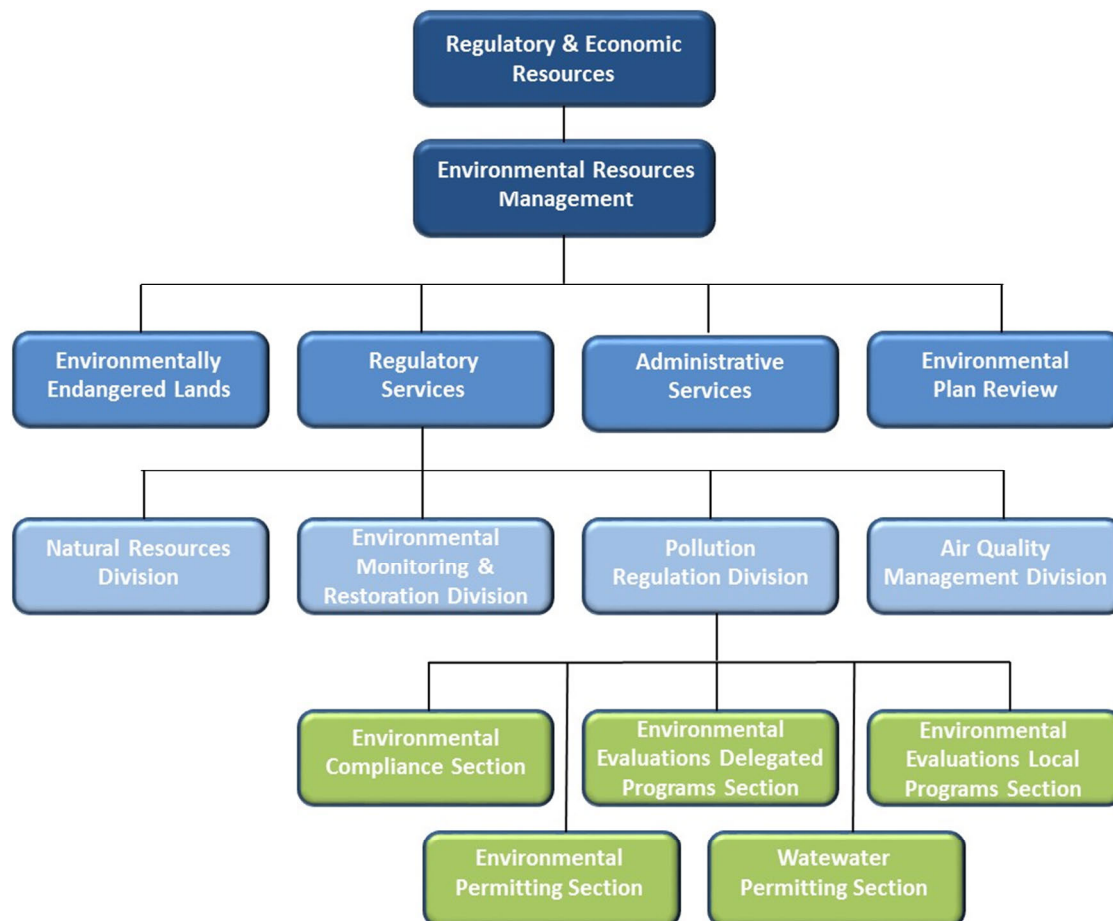
FDEP delegated to RER-DERM the authority to issue and deny, under applicable statutes, regulations, orders, and guidelines, State permits for delegated domestic wastewater facilities (i.e., wastewater residuals treatment, wastewater residuals disposal, and wastewater reuse) as well as all sewage collection and transmission systems, including appurtenant pump stations located in RER-DERM's geographical jurisdiction.

The RER-DERM organization chart is shown in Figure 01.3 and the SSO activities related to the SORP are summarized below.

- The Environmental Compliance Section is responsible for initial response to calls regarding potential SSO events received by the RER-DERM Complaint Desk (which also receives email notifications from MDWASD's Communications Center regarding confirmed SSO events). The Environmental Compliance Section assesses the severity of the reported event and possible impact to stormwater structures or open ground.
- The Restoration and Enhancement Section is responsible for conducting water quality sampling if the SSO is 1,000 gallons or greater or surface waters are impacted. The sampling is conducted to assess potential impacts to receiving waters from the SSO discharge. Data from the water quality sampling is used to make recommendations on when and where to post, and to subsequently remove, warning signs; and to make recommendations for if, when, where, and for how long, public advisories may be needed relative to potential health and environmental impacts from SSO discharges to receiving waters.

- The Wastewater Permitting Section follows up with the SSO impact assessment and starts, or continues, enforcement and is responsible for entering the SSO event into the RER-DERM database for geographic information system (GIS) tracking. The Wastewater Permitting Section coordinates with the Environmental Compliance Section and the Restoration and Enhancement Section and is responsible for permitting domestic wastewater collection and transmission system projects under the FDEP’s delegated authority.
- RER-DERM is also responsible for administering various environmental protection programs such as the County’s Volume Sewer Customer Ordinance (VSCO) and the County’s grease trap permitting program for all non-residential facilities and businesses with the potential for discharging fats, oils, and grease (FOG) to public or privately-owned sanitary sewer systems.

**Figure 01.3**  
**RER-DERM Organization Chart**



## 01.04 SORP Document Organization

This SORP document is organized to meet the requirements of the CD. The SORP document organization is listed in Table 01.1. Where applicable, the corresponding CD paragraph reference is listed adjacent to the section or subsection name and the associated document page number.

**Table 01.1**  
**Location of CD Requirements in the SORP**

CD Paragraph	SORP Section	Page #
	00 Acronyms / Glossary	00-1
	01 Introduction	01-1
Paragraph 19	02 SORP Purpose and Goals	02-1
Paragraph 19	03 Phased SORP Implementation	03-1
Paragraph 19	04 SORP Performance Measures	04-1
	05 SSO Reporting and Notifications	05-1
Paragraph 19(b)(i)	05.03 SSO Notifications	05-6
Paragraph 19(b)(ii)	05.03.1 Immediate 24-Hour Notifications	05-7
	05.03.2 5-Day Written Reports	05-10
Paragraph 19(b)(vii)	05.03.3 Repeat SSOs	05-11
	Appendix D Repeat SSO List for 2014	D-1
	Appendix E Pump Station Upstream Low Manhole List	E-1
Paragraph 19(b)(iii)	05.04 Document Retention	05-14
	06 SSO and Building Backup Response	06-1
Paragraph 19(b)(vii)	06.01 Emergency Response Protocols	06-2
Paragraph 19(b)(iv)	06.02 SSO Control	06-8
Paragraph 19(b)(vi)	07 SSO Response Preparedness	07-1
Paragraph 19(b)(vi)	08 SSO Prevention	08-1
Paragraph 19(b)(v)	08.03 Preventative Strategies	08-7
	09 Climate Change Impacts	09-1
	10 Appendices	10-1

## 02. SORP Purpose and Goals

In accordance with the CD requirement to establish a written, defined purpose and written, defined goals, Section 02.01 provides the SORP purpose and Section 02.02 provides the SORP goals.

### 02.01 SORP Purpose

The purpose of the SORP is to establish and document standardized processes and procedures:

- To protect public health and the environment by reducing the effects of SSOs,
- To provide a coordinated response to SSOs, and
- To improve communication at all levels, including external communication with other agencies, property owners, and the media.

### 02.02 SORP Goals

The SORP goals are to:

- Efficiently respond to, cleanup, and minimize the impact of SSOs and Building Backups,
- Promptly notify potentially impacted public, customers, and agencies during and following SSO and Building Backup events through coordinated communications and outreach,
- Accurately report SSO and Building Backup information and data, especially estimated volumes, durations, causes, and potential impacts,
- Proactively prevent, reduce, or otherwise control SSOs and Building Backups to protect public health and the environment,
- Provide a high level of customer service, and
- Maximize regulatory compliance.

This document contains the initial phase of the SORP plan and a schedule of specific recommendations intended to transition this program into subsequent phases.

THIS PAGE LEFT INTENTIONALLY BLANK



### 03. Phased SORP Development

SORP development and implementation will be phased to ensure cohesiveness and proper integration of the SORP with other CD-required CMOM Programs currently under development. The SORP relies upon the management and implementation efficiency gained through incorporation of specific knowledge area policies, procedures, activities, technologies, and tools inherent to other CMOM Programs. Portions of the SORP that are consistent with existing *Unpermitted Discharges Contingency Plan* (UDCP) activities, which continue to be in effect through approval of the SORP, will be implemented immediately following EPA/FDEP approval. Portions of the recommended SORP activities that will require activities, such as staff training, will be part of the phased implementation process to be completed following EPA/FDEP approval of this SORP. The phased implementation is summarized in Section 03.02, Planned Support Activities, below, as well as noted in the applicable detailed section of this plan document devoted to that particular implementation activity.

#### 03.01 SORP Plan Review and Revision

In accordance with the CMOM philosophy of continuous improvement, MDWASD developed internal performance measures as described in Section 04, SORP Performance Measures, to evaluate SORP progress toward established goals. These performance measures are calculated monthly with semi-annual and annual evaluations.

The defined performance measures may be modified to better suit the business needs of the County. Material changes to the SORP will be submitted to the EPA/FDEP for review and approval and documented in the Annual Report submitted to EPA/FDEP as part of CD reporting compliance.

During the annual evaluation, the performance measures will be evaluated, and lessons learned will be noted to enable MDWASD to continuously improve the SORP and other affected programs. The annual review will also include a review of the effect of other CMOM Programs, changing conditions, revisions to regulatory requirements, and other factors that may impact the SSO response, reporting, or prevention activities. As the SORP matures, less frequent

evaluations may be recommended. The results will continue to be documented in the Annual Report to EPA/FDEP as part of CD compliance reporting.

### 03.02 Planned Supportive Actions

As noted above, the proposed SORP depends on other yet-to-be-developed and implemented new CMOM Programs. The disparity between the required EPA/FDEP submittal dates for these CMOM Programs not only demonstrates a need for a phased implementation approach, but the need to consolidate new CMOM Program implementation schedules. Upon EPA/FDEP approval of other CMOM Program plan documents, MDWASD will submit a proposed consolidated implementation plan and schedule to include CMOM Programs. This will facilitate the task of tracking implementation for CMOM programs, individual CMOM elements, required resources, and schedules.

Implementation of the SORP is contingent upon distinct CD controlled and non-CD controlled predecessors. These include, but are not limited to:

- Submittal, subsequent EPA/FDEP approval, and implementation, of the Information Management System (IMS) CMOM Program that will facilitate performance measure monitoring and will provide accurate data for repeat SSOs; and
- Completion of the Miami-Dade GIS Updates and addition of accurate manhole rim and invert elevations upstream of pump stations that will facilitate identification of potential SSO locations associated with surcharged sewers caused by pump station problems.

#### 03.02.1 Phased Implementation Actions

The proposed staffing for the phased implementation of the SORP is detailed in Section 07, SSO Response Preparedness. Table 03.1 summarizes the key implementation activities.

#### 03.02.2 Implementation Schedule

The SORP will be implemented in phases as summarized below:

- **Immediate.** The initial SSO reporting, emergency response, and cleanup procedures consistent with the existing UDCP are being implemented immediately as on-going

MDWASD activities. SSO reporting form revisions are also underway by MDWASD's Information Technology (IT) staff to include line items in each 5-day SSO report form to identify previous SSOs at the same point within the previous year (i.e., "repeat SSOs") and to include an SSO recovery volume amount where recovery was possible. The IT staff are also developing a similar Building Backup Notification form to track Building Backup events.

- **Upon EPA/FDEP Approval.** Upon EPA/FDEP approval of this SORP and the other CMOM Program documents for which SORP dependencies exist (i.e., the IMS Program, the GIS Program, etc.), the SSO Consolidated Database, the Building Backup Database, and performance measure tracking will be implemented.
- **Within One Year of EPA/FDEP Approval.** The final phase of SORP implementation is anticipated to occur within one year of EPA/FDEP approval and will include preparedness training to facilitate compliance with the SORP and two proactive measures to further reduce incidents associated with "contractor hits." These measures are the Active As-built Supplemental Information System (AASIS) Process Refresher Training and the Contractor Outreach Workshop (or other educational measure as may be identified). The actual timing of SORP implementation will be defined based on SORP dependencies with other CD CMOM Programs and the ability to achieve recommended staffing levels in the various CMOM Programs, including this SORP.

**Table 03.1**  
**Proposed SORP Phased Implementation Activities**

Activity	Abbreviated Description
Revised Domestic Wastewater/Abnormal Event Notification Form	MDWASD IT staff will include additional fields in the notification form to incorporate repeat SSO identification for each SSO incident.
Building Backup Notification Form	MDWASD IT staff will develop a Building Backup notification form based on the example in the SORP Appendix B, Example Building Backup Notification, similar to the Domestic Wastewater/Abnormal Event Notification form for use in reporting and tracking Building Backups.
SSO Consolidated Database	MDWASD IT staff will complete on-going improvements to incorporate additional tracking capabilities to ensure the elements of the separate tracking systems are incorporated into an Enterprise system application that allows for access across departmental barriers, including RER-DERM access to read data.
Building Backup Database	MDWASD IT staff will incorporate the Building Backup tracking capabilities into the SSO Consolidated Database activity to ensure compatibility and ease of access.
Performance Measure Tracking	In conjunction with the Information Management System (IMS) Program, MDWASD IT staff will implement measures to record, track, and report on SORP performance measures as listed in Table 04.1.
Preparedness Training	MDWASD staff involved in SORP-related activities will attend training activities, including workshops, field training, and/or coordination/training meetings to ensure staff are fully informed of the SORP-provisions; are able to effectively implement such SORP-provisions; and are equipped with the appropriate knowledge and resources to carry out their job responsibilities in a prompt and efficient manner. The training will also include an emphasis on environmental and public health protection measures. For example, response crews will be trained to recognize the boundaries of the Critical Wildlife Area in Biscayne Bay so that appropriate measures can be implemented to reduce the potential spill impact to sensitive habitat areas.
AASIS Process Refresher Training	Utility Locations and Special Billings staff will attend refresher training on the Active As-built Supplemental Information System (AASIS) process to ensure asset location or data attributes found during field activities to be incorrectly input into the GIS mapping and the EAMS asset inventory databases are corrected according to the field-determined findings in a prompt, efficient, and accurate manner.
Contractor Outreach Workshop	Utility Locations and Special Billings staff will offer a Contractor Outreach Workshop, or other educational activity as might be identified, to assist contractors and other third parties to effectively use the Sunshine Ticket program to improve utility locations response times and location accuracy thus minimizing the potential for contractor damage to MDWASD's infrastructure.
Low Manhole Identification	The current low manholes identified upstream of pump stations is a preliminary identification that may not include all pump stations and is subject to refinement in elevations that are being developed in MDWASD's GIS Program. Once the refined GIS data is available, the PSD Operations Engineer (new staff position) will refine the identification of low manholes upstream of MDWASD-owned pump stations (excluding private pump stations and private collection systems).

## 04. SORP Performance Measures

In accordance with the CD requirement that MDWASD establish performance measures and develop written procedures for periodic review, Section 04.01 establishes the purpose for the performance measure program; Section 04.02 lists the SORP performance measures; and Section 04.03 describes the on-going evaluation and review activities.

### 04.01 Purpose of Performance Measures

Performance measures, which compare actual performance against an established performance standard, benchmark, target, or level of service (LOS), help identify the relative health of specific operational areas. Performance measures include a subset of measures termed key performance indicators (KPIs). KPIs measure the relative health of the SORP reporting, response, and prevention measures by comparison of actual system performance to system LOS targets. System managers use performance measures to justify, allocate, and/or reallocate resources to underperforming areas; plan and develop budgets for additional resources; evaluate and document the effectiveness of different practices and procedures. In addition to efficiently conveying system and sub-system performance to wide audiences, system managers use performance measures to make comparisons of systems across time and geography. MDWASD will implement use of a performance measure and KPI target system to evaluate SORP progress towards achieving the CD goal in accordance with the CMOM philosophy for continuous improvement.

### 04.02 Established Performance Measures

MDWASD has adopted a number of initial KPIs to meet County and SORP goals, and to ensure that MDWASD's successes are properly documented and reported. These KPIs will assess the overall effectiveness of the SORP and will enable MDWASD to make adjustments in the program to achieve the established MDWASD performance goal or target to meet CD and LOS requirements. Table 04.1 presents the KPIs that MDWASD will employ to measure, track, and report performance of the SSO and Building Backup reporting, response, and prevention activities. Table 04.1 also presents the initial target for each KPI performance measure.

**Table 04.1**  
**Key SORP Performance Indicators**

Key Performance Indicator	Target
Annual average SSO response time <sup>1</sup>	90 min
Annual average SSO control time <sup>2</sup>	
For small diameter gravity sewers	90 min
For large diameter gravity sewers	120 min
For force mains	120 min
For pump stations	4 hours
For Regional Pump Stations <sup>3</sup>	8 hours
Annual number of SSO events per 100 miles of gravity sewer <sup>4</sup>	< 2 / 100 mi
Annual number of pump station-related SSO events per 100 pump stations <sup>5</sup>	< 1 / 100 PSs
Annual hours of SORP preparedness training per employee <sup>6</sup>	4 hours

<sup>1</sup> Average of the time from the initial notification is received at the Communications Center until the time the MDWASD response crew arrives on-site for all confirmed SSO events, excluding Building Backups, occurring during the previous year.

<sup>2</sup> Average of the time from the MDWASD response crew arrival on-site until the time the SSO, excluding Building Backups, discharge from the stated asset is stopped for SSO events occurring during the previous year.

<sup>3</sup> Regional Pump Stations are stations categorized as “regional” through a combination of station function and geographic location. Regional stations typically receive flow from other lift stations and were frequently constructed to replace small package-type wastewater treatment facilities that had been acquired by MDWASD.

<sup>4</sup> Annual number of confirmed gravity sewer-related SSO events divided by the year-end total miles of gravity sewer within MDWASD’s WCTS for the previous year.

<sup>5</sup> Annual number of confirmed pump station-related SSO events divided by the year-end total number of MDWASD owned and maintained pump stations within MDWASD’s WCTS for the previous year.

<sup>6</sup> Total hours of SORP preparedness training divided by the number of MDWASD staff assigned to SSO response crew duties during the previous year.

The KPIs shown in Table 04.1 are specific to the SORP. Other CMOM Programs have KPIs specific to that program such as the GSSOMP, which has a KPI relating to blockages that do not result in SSO events.

### 04.03 Performance Metric Reviews and Revisions

Since one purpose of MDWASD’S CMOM Programs is to achieve continuous improvement, the MDWASD’s management team will periodically evaluate each performance measure and may revise or change performance measures based on relevancy and value to the successful implementation and management of the SORP. MDWASD’s management team will review KPI

actual performance versus target measures on a semi-annual basis to track performance versus progress toward the goal. MDWASD's management team will also assess trends and needs for adjustments to preventative maintenance schedules and staffing and funding levels. These semi-annual reviews may also drive modification of other CMOM Program element changes or revisions. Due to the diverse organizations involved in SSO-related performance measures versus Building Backup-related performance measures, the review meetings for each category (i.e., SSOs and Building Backups) will be conducted separately.

MDWASD'S management review team responsible for semi-annual and annual performance measure reviews consists of:

- The WWCTLD Chief (or delegate),
- The PSD Chief (or delegate),
- The WWTMD Chief (or delegate) if any SSOs occurred associated with the influent sewers, influent pump stations, or influent force mains during the previous 6-month period,
- The Assistant Superintendents (as assigned by the respective Division Chief),
- The Liability Claims Administrator, and
- The Assistant Director of Regulatory Compliance and Planning (or delegate).

THIS PAGE LEFT INTENTIONALLY BLANK



## 05. SSO Reporting and Notifications

Section 5 outlines SSO reporting and notification procedures. Section 05.01 summarizes reporting requirements. Section 05.02 describes how SSO and Building Backup events are identified. Section 05.03 describes the SSO notifications that are completed. Section 05.04 contains MDWASD's document retention policies.

### 05.01 SSO Reporting Requirements

Under Florida Administrative Code (F.A.C.) Chapter 62-604.550 for any SSO that:

- Reaches waters of the United States or the State;
- Discharges in excess of 1,000-gallons, or
- Endangers public health or the environment,

MDWASD must, within 24 hours, provide an oral report to FDEP through the Florida State Watch Office and the State Warning Point Hotline at (800) 320-0519, with details of the SSO to the extent known. F.A.C. Chapter 62-04.550(2)(b) requires oral reporting within 24 hours for spills or releases of 1,000 gallons or less. Chapter 62-04.550(2)(c) waives the 5-day written report, which is detailed below, if the oral report was received within 24 hours, if the discharge did not endanger public health or the environment, and the release, spill, or abnormal event has been corrected.

MDWASD must, within 5 days and unless the above waiver applies, provide a written report to FDEP. However, the reality is that the above waiver rarely applies since regulatory authorities consider all SSOs to be public health and environmental threats. Further, the CD requirements described below to report SSOs supersedes state legislative requirements. Thus, MDWASD adopts a conservative interpretation of F.A.C. Chapter 62-604.550 to complete 5-day written reports of all SSOs that reach water or discharge more than 1,000 gallons. The written report must contain the following elements:

- The location of the SSO by street address or any other appropriate measure (such as latitude/longitude or global positioning system (GPS) coordinates).

- The estimated date and time when the SSO began and stopped, or if it is still an active SSO, the anticipated time the SSO will stop.
- The steps taken to respond to the SSO.
- The name of the receiving water, if applicable.
- An estimate of the volume (in gallons) of sewage spilled.
- A description of the WCTS component (e.g., manhole, sewer, air release valve, force main, pump station wet well, public lateral, private lateral, public cleanout, private cleanout, etc.) from which the SSO was released.
- An estimate of the SSOs impact on public health and to water quality in the receiving water body, subject to available information.
- The cause, or suspected cause, of the SSO.
- The date of the last SSO at the same point.
- The steps taken to reduce, prevent, or eliminate recurrence of the SSO.
- A list of all notifications to the public and other agencies or departments.
- The steps taken, or to be taken, to cleanup any surfaces that have been in contact and/or contaminated by the SSO.

Such reports are submitted to: FDEP Southeast District Office, 2201 Gun Club Road, MSC 7210-1, West Palm Beach, FL 33406, Phone (561) 681-6600.

Under the proposed changes to County Code Chapter 24-42.2 all utilities are required to verbally report all SSOs regardless of size to RER-DERM within 4 hours of identification. RER-DERM reports are submitted to: RER-DERM, Overtown Transit Village North, 701 NW 1<sup>st</sup> Court, Miami, FL 33136, Phone (305) 372-6955.

In addition to FDEP- and County Code-required SSO notifications, MDWASD is required to report on SSOs and Building Backups in quarterly and annual reports to EPA/FDEP under the CD requirements. Building Backups, since they are defined as a type of SSO event under the CD, require notifications for large backup events that exceed the 1,000-gallon reporting

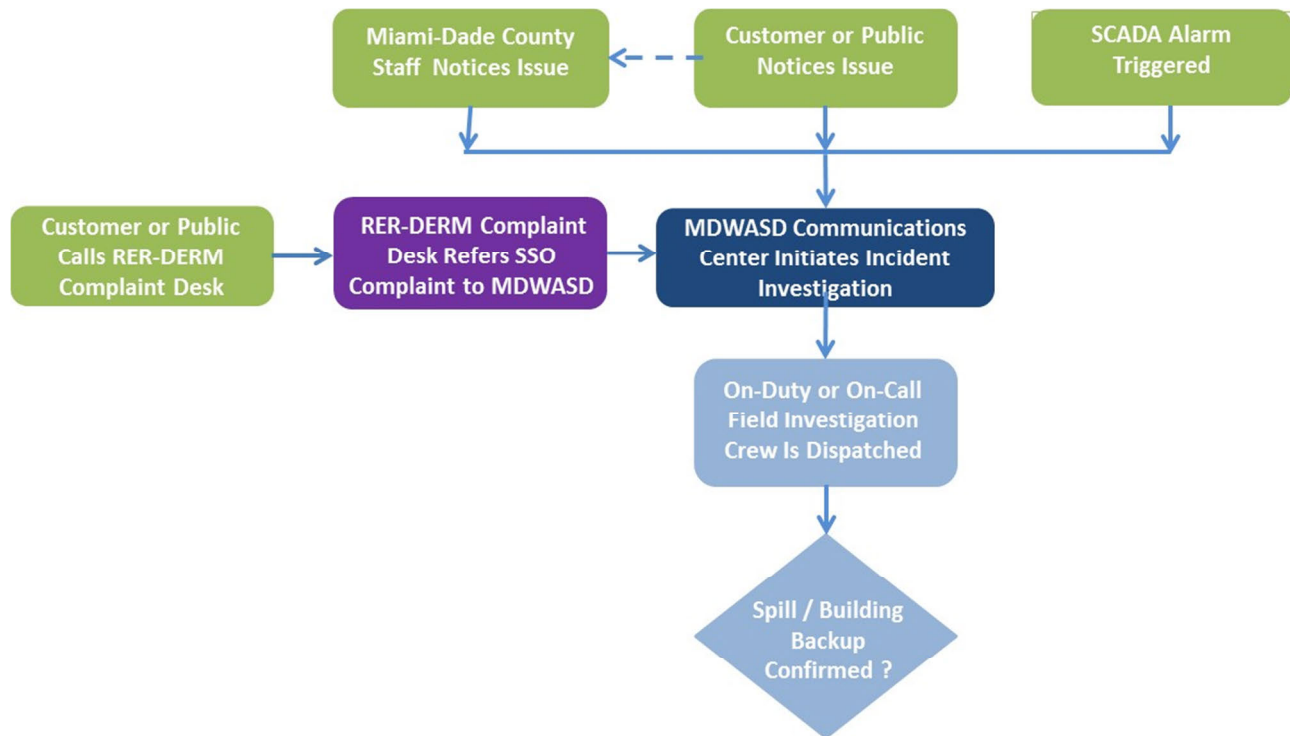
threshold. Due to privacy considerations, the fact that these events are almost always under 1,000 gallons, and the lack of public health and environmental impact, individual building backup events that are caused by conditions on the public sewer or public lateral are not considered subject to public or agency notifications except for inclusion in quarterly and annual CD reports.

## 05.02 SSO Identification

Possible SSOs, including potential Public Building Backup events, are identified by a number of sources as depicted in Figure 05.1. The most common identification source is when a customer or the public calls to report a problem such as an overflowing manhole, a foul-smelling discharge, a pump station alarm horn or light, slow-draining or stopped drain, or backed-up drain. However, potential overflow events may also be directly identified by MDWASD or other County staff or by automatic alarms activated by MDWASD's remote monitoring systems. MDWASD and County staff are directed to inform the Communication Center, manned by the Emergency Communications Section and housed in the Douglas Road facility, of potential SSOs. MDWASD's supervisory control and data acquisition system (SCADA) alarms are routinely monitored by Communications Center staff, on a 24/7/365 basis and whom are responsible for initiating field response protocols based on the severity of those alarms.

RER-DERM also maintains a RER-DERM Complaint Desk that receives calls from the public relating to environmental problems. Customers and the public may direct SSO complaints to the RER-DERM Complaint Desk rather than directly to MDWASD. In these cases, the RER-DERM Complaint Desk records the complaint in a RER-DERM complaints database and, if the complaint seems to involve an on-going SSO, instructs the complainant to contact MDWASD's Communications Center to ensure proper initiation of SSO response measures in a timely manner. Similarly, upon verification of an SSO event, MDWASD's Communications Center ensures the RER-DERM Complaint Desk is aware of the event. A RER-DERM Inspector will verify if the SSO has impacted any structure that has direct impact to surface waters to ensure proper initiation of SSO water quality sampling protocols. Customers are unlikely to call the RER-DERM Complaint Desk for Building Backup events, but if RER-DERM receives such a call, the customer is directed to contact MDWASD's Communications Center.

**Figure 05.1**  
**Incident Identification Flow Chart**



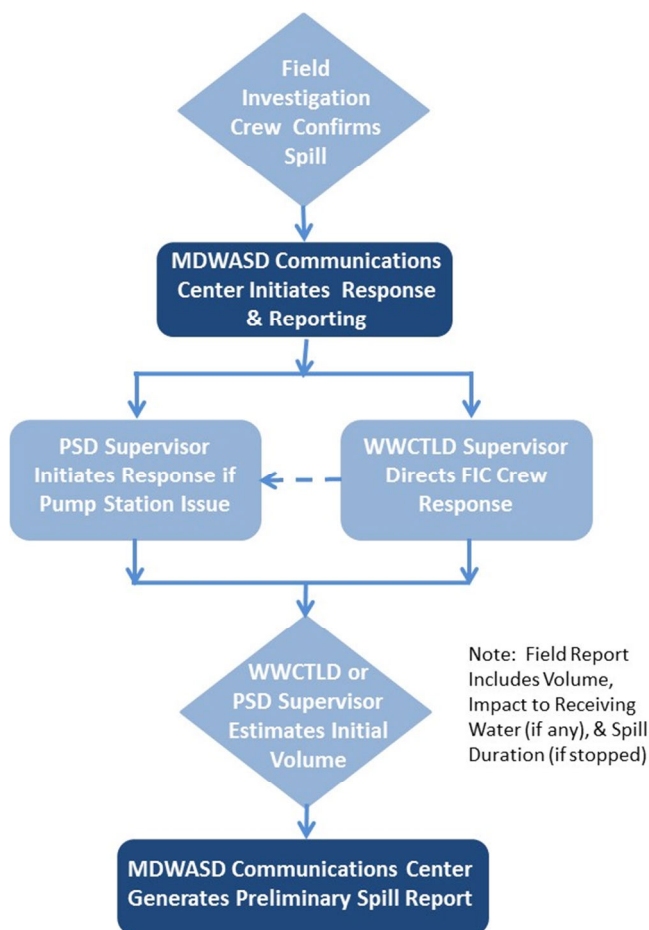
Once an incident involving a potential SSO has been identified, MDWASD’s Communications Center creates a service request and dispatches a WWCTLD or PSD Field Investigation Crew (FIC) to verify an unpermitted discharge is occurring (or has occurred). The SSO and Building Backup field response procedures are defined in detail in Section 6, SSO and Building Backup Response, but the initial office response activities leading up to public and agency notifications are illustrated in Figures 05.2 and 05.3 and outlined below.

As shown in Figure 05.2, once the dispatched MDWASD FIC confirms an SSO, either the WWCTLD Supervisor or the PSD Supervisor directs the field response activities and makes an initial SSO volume range determination to define the type of public or agency notification required. Based on this basic field information, the Communications Center initiates the notifications as defined in detail in Subsection 5.03, SSO Notifications. Additional detail on the SSO notification is included in Appendix C, Verbal and Electronic Notification Flow Chart.

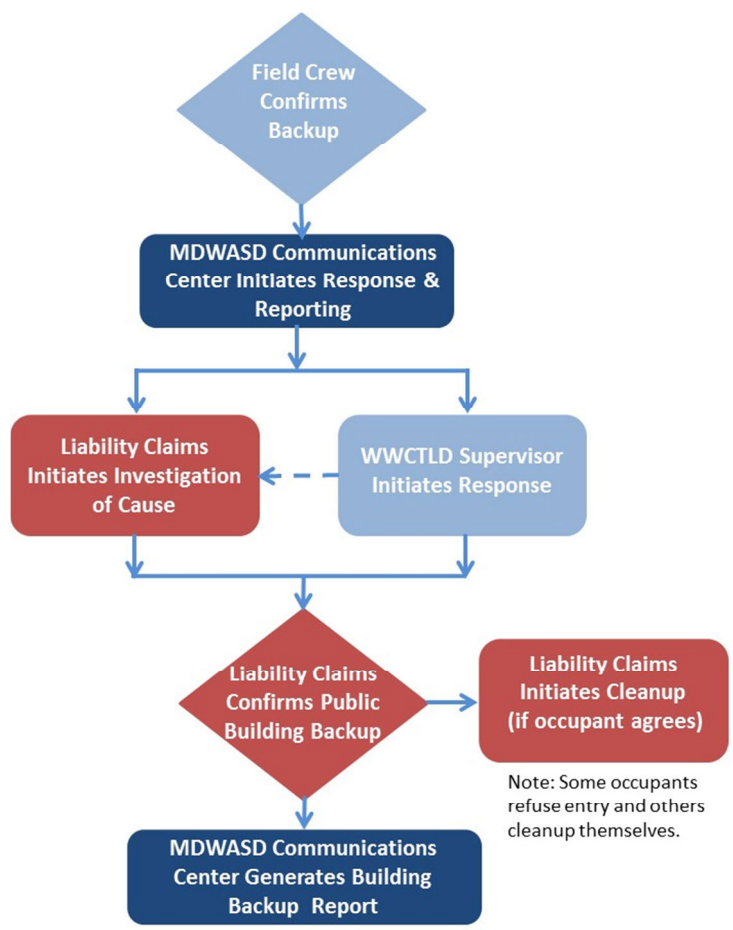
As shown in Figure 05.3, a similar process is initiated for Building Backups such that MDWASD’s FICs respond to confirm a MDWASD-caused Public Building Backup and, if the

backup is on-going, initiate measures to stop the backup. (In the unlikely event that a Building Backup reaches the 1,000-gallon threshold, 24-hour oral and 5-day written agency notification reports are required.) At the same time, Liability Claims Administration staff are informed to initiate the claim process and to arrange for cleanup contractors to respond. For Building Backups that customers do not report during, or immediately after, a backup, no FIC response is required, but MDWASD's Liability Claims Administration still responds to verify the backup and research sewer conditions as well as any O&M activities being performed in the neighborhood during the reported date of the backup event to determine MDWASD's responsibility. Cleanup reimbursement may be offered for Public Building Backups with proper documentation.

**Figure 05.2**  
**SSO Investigation Flow Chart**



**Figure 05.3**  
**Building Backup Investigation Flow Chart**

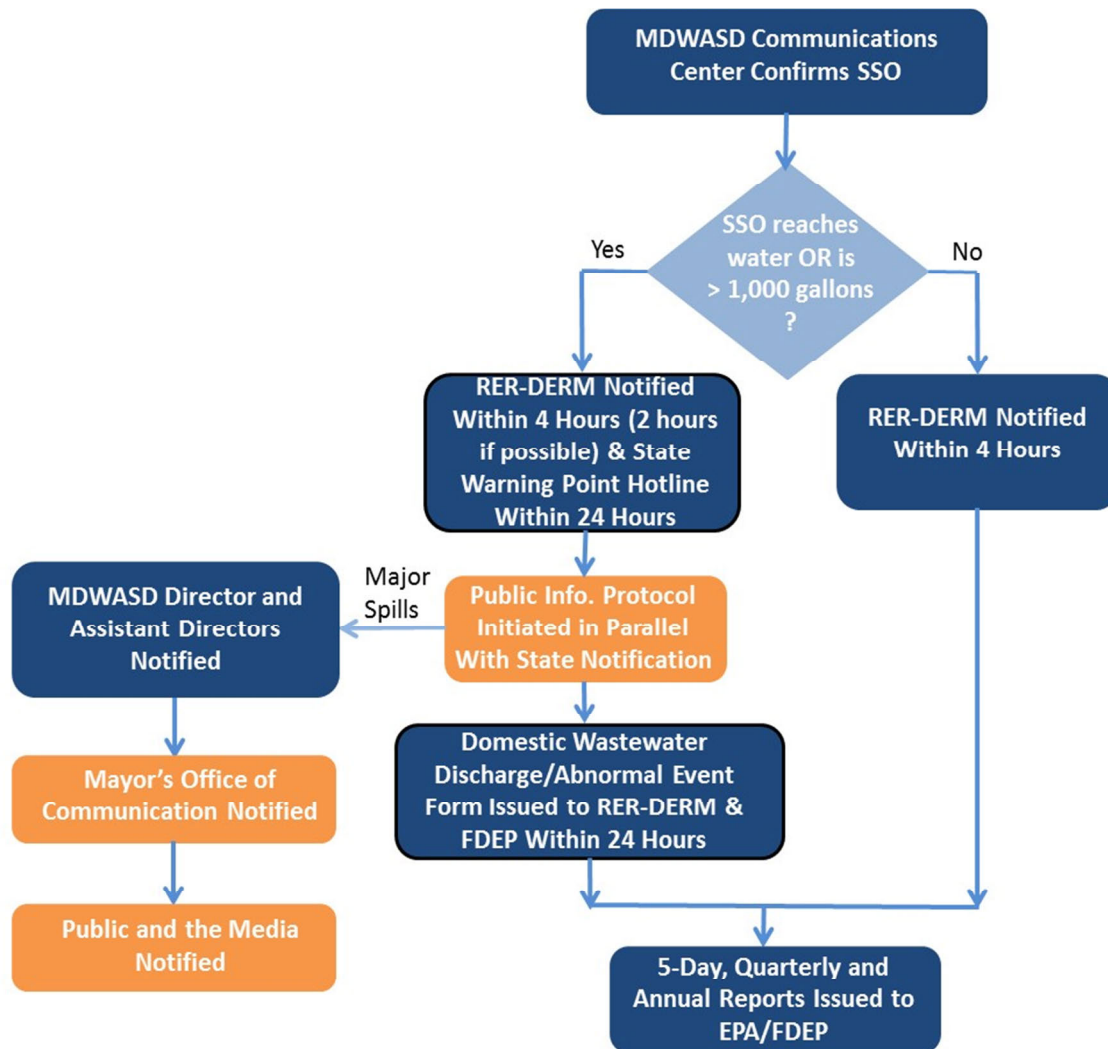


### 05.03 SSO Notifications

Figure 05.4 on the following page provides an overview of MDWASD’s SSO notification procedures. These procedures are documented in the following subsections below the figure.

- Subsection 05.03.1. Immediate 24-hour notifications,
- Subsection 05.03.2. 5-day written reports,
- Subsection 05.03.3. Repeat SSOs, and
- Subsection 05.03.4. Building Backups.

**Figure 05.4**  
**SSO Notification Overview Flow Chart**



### 05.03.1 Immediate 24-Hour Notifications

A primary goal of the immediate 24-hour notification is to minimize the potential adverse impacts on public health for users of area waters that might become contaminated by unpermitted wastewater discharges. A secondary goal is to comply with local, state, and federal regulatory requirements. MDWASD's protocols and procedures to meet these goals are described in the following subsections on Public Notifications and Regulatory Notifications, respectively.

**Public Notifications.** Confirmed SSO events that discharge to surface waters and discharge a volume greater than 1,000 gallons trigger initiation of public notification protocols. Public Notification Protocols are initiated immediately upon the Communications Center becoming aware that a major spill is occurring. Major spills are large (roughly 50,000 gallons or more), ongoing, or endanger public health or the environment. The Water Quality Impact Committee (WQIC) is responsible for determining when, and at what level, public notifications are required. The WQIC consists of representatives from MDWASD, RER-DERM, Florida Department of Health (DOH) and Office of Emergency Management (OEM). Upon determination of a major spill requiring public notification, the Regulatory Compliance Section coordinates public notification with MDWASD's Public Affairs Section Chief. Public Affairs then coordinates the press releases with the Miami-Dade Mayor's Office of Communications.

During normal business hours, MDWASD's Public Affairs Office provides releases to the Mayor's Office of Communications for email distribution to County representatives and to English, Spanish, and Creole media outlets. Outside of normal business hours, MDWASD's Communications Center emails the news release provided by the Public Affairs Section Chief to a pre-established distribution group provided by the Miami-Dade Office of Communication (MDOC). Depending on the severity of the incident, the Office of Emergency Management has the option of providing for land-line telephone notification of residents in the affected areas through the use of a "Reverse 311" process. Pre-scripted news releases are available for editing and prompt release to provide updates during the incident. Additional public notifications using "Facebook" and "Twitter" are also being used. SSOs that do not discharge to surface waters and do not meet the 1,000-gallon threshold are not subject to public notice. Similarly, Public Building Backups are not subject to public notice except in the unusual situation where the

threat of localized flooding and wide-spread backups exists where the backups have the potential to adversely impact public health.

The news release will characterize the situation, advising of any health risks, describing any special conditions, such as traffic disruption required to permit necessary repairs, and making appropriate requests of the public to limit water use. The news release will also include the affected bodies of water and public advisories regarding the impacts to swimming and recreational activities.

As noted above, the WQIC determines when and at what level public notifications are required. When the WQIC determines a public notification is required, the agencies draft the advisory as a team and coordinate the posting of warning signs to minimize or prevent public access to sites where a potential health threat may exist. RER-DERM's water quality sampling plan forms the basis for sign posting locations as it is based on receiving water connectivity and flow patterns. For significant discharges to receiving water, the signs are posted by WWCTLD or PSD field staff the day the SSO occurs and remain in place until RER-DERM sampling results indicate water quality has returned to published guidelines for the water body's use. Once the repairs have been completed and the results of water quality monitoring in the affected water bodies and shoreline areas are available, the RER-DERM emails the water quality results to the WQIC. The determination of when the public access postings can be removed is based upon the coliform bacteria testing results in the affected areas. Bacteria counts must be less than published guidelines for the water body's use for DOH to determine that swimming and other recreational water contact activities can be resumed. The MDWASD representative (from the Regulatory Compliance Section) notifies the Communications Center when the public access advisory is rescinded and instructs the PSD Chief to remove the public access advisory signs.

The Communications Center bases the information and data provided in the Preliminary Spill Report on information provided by the FIC and the applicable WWCTLD or PSD Supervisor responsible for the SSO response activities. The information on cause is based on conditions readily observable in the field and is subject to change based on more detailed, follow up investigations. The estimated SSO volume should also be considered preliminary as it is based on field calculations performed under strenuous time constraints and field-observed data.



Especially with force main leaks, the amount of water rising to the ground surface can frequently be relatively small and it is only after extensive excavation that potentially larger volume releases become visible. In a limited number of cases, the SSO volume estimate revision may mean that an SSO discharge originally believed to be under 1,000 gallons was actually over 1,000 gallons. Such revisions in estimated volume have the potential to delay water quality sampling or initiating public notification protocols. Efforts are made to prevent such delays by such actions as preparing to mobilize sampling crews whenever an SSO event is reported as on-going so that if the 1,000-gallon threshold is exceeded, the crews are prepared to sample.

**Agency Notifications.** Upon confirmation from the FIC of an SSO event, the Communications Center initiates a preliminary spill report and notifies RER-DERM so that inspection can be performed and, if needed, applicable water quality sampling protocols can be started. The preliminary spill report is a preliminary version of the Domestic Wastewater Discharge/Abnormal Event Notification Form used for the FDEP 24-hour and the RER-DERM notifications, which is shown in Appendix A, Example Domestic Wastewater/Abnormal Event Notification Form. As an SSO, Public Building Backups that are caused by MDWASD are subject to agency notifications, but usually do not meet the 1,000-gallon reporting threshold.

RER-DERM must be notified of all SSO events, regardless of size, within four hours; however, MDWASD's internal goal for reporting SSOs discharging to waters of the United States or the State to RER-DERM is within two hours of the time the FIC confirms the SSO event so that inspection can be performed to determine if water quality sampling protocols should be initiated. It should, however, be noted that the primary goal for MDWASD's first responders is to stop the overflow event rather than divert resources to reporting and notification activities to maximize public health and environmental protection by minimizing discharge volume. Upon notification by the responders, the Communications Center emails the notice to the RER-DERM Complaint Desk.

For spill events that exceed the 1,000-gallon threshold, the Communications Center also notifies FDEP through the Florida State Water Office and the State Warning Point Hotline.

## 05.03.2 5-Day Written Reports

SSO events exceeding the 1,000-gallon threshold, discharging to surface water bodies, or endangering public health or the environment, are reported to RER-DERM and FDEP through a follow up written report on a completed, and updated as needed, version of the Domestic Wastewater Discharge/Abnormal Event Notification form. Appendix A, Example Domestic Wastewater Discharge/Abnormal Event Notification, shows a sample of this notification. Any time the form is updated from the SSO database, revisions are noted in red and the revision date noted. Based on the CD requirement to report the date of the last SSO occurring at the same point (as described in Subsection 05.03.3, Repeat SSOs), the Domestic Wastewater Discharge/Abnormal Event Notification form has been modified to add a line item with this information. The form has also been modified to include a line item to report the estimated SSO volume recovered and returned to the WCTS during SSO emergency response activities. The existing notification form will continue to be used until the new form is approved by EPA/FDEP as part of the approval of this SORP.

MDWASD's Regulatory Compliance Section is responsible for submitting a 5-day letter and supporting data such as the updated Domestic Wastewater Discharge/Abnormal Event Notification form to RER-DERM and FDEP. The data used to populate the form is compiled primarily from work order information entered into EAMS, which has been verified, and potentially corrected, by WWCTLD and PSD supervisors as needed. The flow chart in Appendix C, Verbal and Electronic Notification Flow Chart, provides an overview of the 24-hour oral and 5-day notifications and provides listings of the telephone and email recipient agencies.

Upon full implementation of this SORP, any Building Backups exceeding the 1,000-gallon reporting threshold for SSO events that are found to be Public Building Backups caused by conditions on the public side of the sewer system will be reported to RER-DERM and FDEP through a follow up written report on a similar form as shown in Appendix B, Example Building Backup Event Notification. MDWASD will start using this form following EPA/FDEP approval of this SORP. The Regulatory Compliance Section will be responsible for completing a 5-day letter and the verified, and potentially corrected, form based on information populated in EAMS and provided by the Claims Administration Section in a similar process to that followed for SSOs.

While the CD is in effect, the Regulatory Compliance Section is also responsible for tabulating and summarizing SSO and Building Backup events for inclusion in the quarterly and annual reports submitted to EPA/FDEP. The CD reporting requirements include all SSO and Building Backup events regardless of size while the 24-hour oral and 5-day written reports include only those events exceeding the 1,000-gallon threshold discharge volume (or which reach surface water or endanger public health or the environment). Building Backups that are not promptly reported to MDWASD cannot be verified by MDWASD field crews and are not reported, although a follow up damage claims investigation may be performed.

### 05.03.3 Repeat SSOs

As noted above, the CD requires MDWASD to identify the date of the last SSO at the same point in the 5-day written report to RER-DERM and FDEP. MDWASD records all SSO and Building Backup events and associated work orders in the department's computerized maintenance management system, or EAMS. The events are recorded by both address and by asset to ensure accurate record keeping.

Recording SSO events by location alone leads to confusion when multiple assets are located in the same vicinity. For example, an address may indicate gravity lines on either side of the street, a force main paralleling the street, or a nearby pump station. Recording SSO events by asset alone leads to confusion for linear assets such as gravity sewers or the even longer force mains that extend past multiple addresses. Thus, protocols to identify repeat SSOs are developed to query EAMS work order records for both address and asset to ensure accurate retrieval of historic SSO data. These queries are performed by the WWCTLD Supervisor assigned to respond to the current event and any previous events identified recorded on the revised Domestic Wastewater Discharge/Abnormal Event Notification form.

As required by Paragraph 19(b)(vii) of the CD, Appendix D, Repeat SSOs for Period Ending March 30, 2015, contains the list of repeat SSO locations identified the preceding 12 months. Paragraph 19(b)(vii) also requires the identification of locations at which an SSO is likely to occur first in the event of a pump station failure. These locations would be the lowest manhole upstream of each pump station. Appendix E, Pump Station Upstream Low Manhole Identification, contains the current list of low manholes upstream of each of MDWASD's pump

stations. The listing in Appendix E is based on data as of the end of Calendar Year 2014 and is subject to periodic updating based on the addition or deletion of pump stations and on refined survey elevation data from the on-going GIS improvement activities. Appendix E does not include identification of low manholes in the private collection systems upstream of either private pump stations or pump stations maintained by the PSD under maintenance agreements (e.g., proprietary stations). The listing in Appendix E will be continuously replaced as additional data and more accurate data become available. This responsibility will be performed by the new staff position of PSD Operations Engineer as defined in Table 07.1 in Section 7, SSO Response Preparedness, of this document.

#### 05.03.4 Building Backups

As previously noted, Building Backups caused by conditions on the public sewer or public lateral are defined as SSO events under the CD. As an SSO event, Building Backups are now subject to SSO reporting and notification requirements detailed in the preceding subsections as summarized below for convenient reference purposes.

- Individual Building Backups that are promptly identified to MDWASD are subject to immediate response by the FIC as directed by the Communications Center and, if the 1,000-gallon threshold is exceeded, are subject to 5-day written report requirements to RER-DERM and to FDEP Southeast District plus CD reporting for all volume events.
- Individual Building Backups are subject to subsequent cleanup by MDWASD's contract cleaning vendor when confirmed by the FIC to be caused by conditions on the public sewer or public lateral and cleanup is authorized by Liability Claims Administration.
- Individual Building Backups that are not identified promptly (i.e., within 90 days of the event or which MDWASD field crews cannot verify) and which have been cleaned up by the customer or their contractor, are only subject to records review by MDWASD and possible cleanup cost reimbursement if the records review determines conditions on the public sewer or public lateral caused the event. Since these events were not promptly identified, the events are not included in any of the required regulatory reports due to the difficulty of verifying the event or whether the cause was public or private.

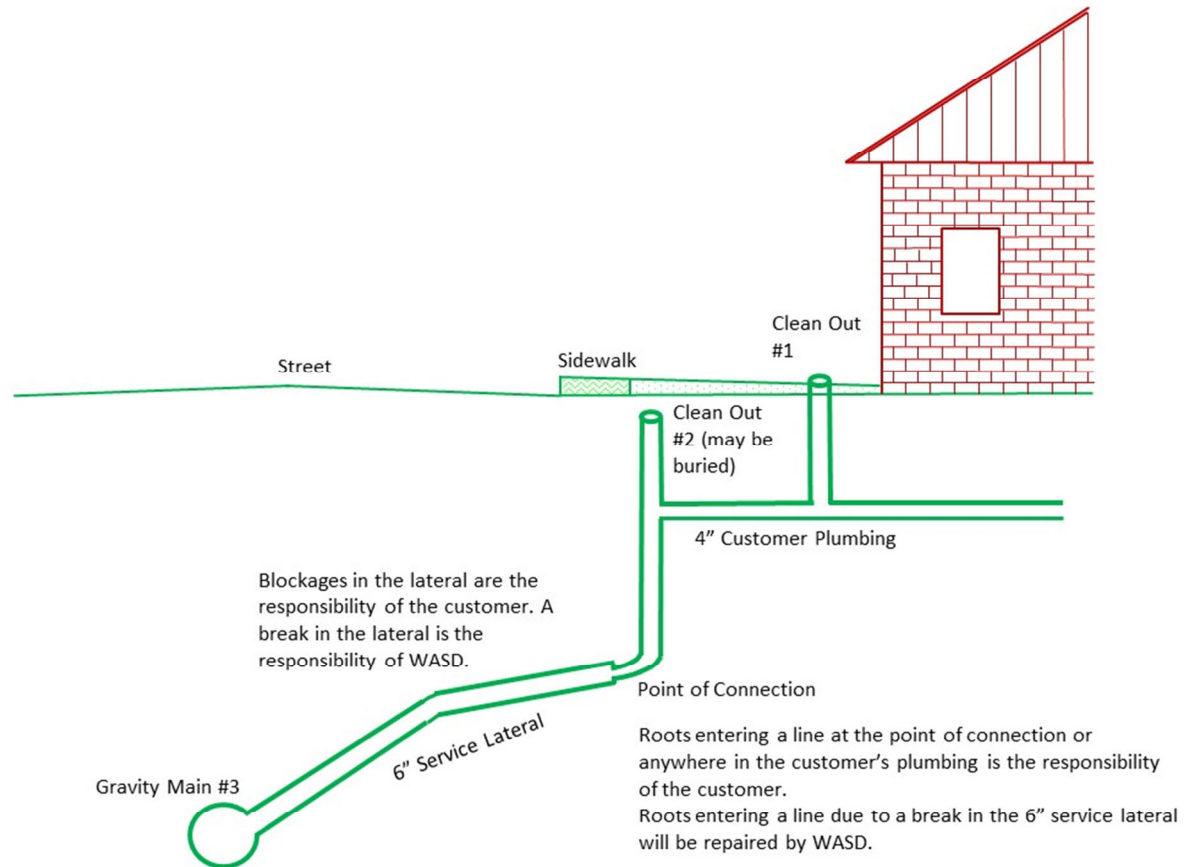
- Individual Building Backups that are “splashes” associated with MDWASD public sewer cleaning crews and are caused by customer plumbing conditions (i.e., air pockets in the plumbing, clogged air vent, etc.) are defined as Private Building Backups and thus are not SSOs, but are cleaned up, or subject to cleanup cost reimbursement, depending on the timeliness of the customer complaint, by MDWASD’s contract cleaning vendor as a customer service since the sewer cleaning contributed to event.

MDWASD has adopted regulations regarding the customer’s responsibility in regards to maintenance of laterals. Figure 05.5 illustrates a typical lateral installation serving a single property and defines maintenance responsibilities for the private lateral from the connection at the service lateral into and including the house plumbing and for the public lateral from the public sewer main to the cleanout at the right-of-way or easement line. As shown in the figure, two cleanouts are required: Cleanout #1 at the building and Cleanout #2 at the right-of-way or easement line.

The customer is responsible for repair and maintenance of the house connection (i.e., private lateral) to Cleanout #2. The customer is also responsible for keeping the service lateral (i.e., public lateral) free from obstructions to the connection at the public sewer. MDWASD is responsible for repairs to the service (or public) lateral.

During a Building Backup event, the customer may occasionally remove the cleanout cap on Cleanout #1 to alleviate flow entering the building. This causes an SSO discharge to the environment. If the overflow cause is determined to be on the public side and MDWASD is made aware of the discharge, the SSO is reported by MDWASD as a public SSO. If the overflow cause is determined to be on the private side, and MDWASD is made aware of the discharge, the SSO is reported by MDWASD as a private SSO. In some cases, MDWASD will not be aware of the discharge and in those cases the private SSO is not reported.

**Figure 05.5**  
**MDWASD Lateral Maintenance Protocol Diagram**



Miami-Dade Water and Sewer Department (MDWASD) recommends contacting a licensed plumber to work from the #1 and #2 clean outs prior to placing a service call. MDWASD does not work on private property nor is it responsible for blockages in the service lateral. To clean a blockage in the lateral (for a fee of \$125), the customer must provide the service crew access to the #2 clean out. No service fees are applied to customers who experience sewer backups due to blockages in the gravity main (#3), breaks in the gravity main, and/or 6" service lateral.

\*\*\*Note: In areas of Miami-Dade County the sewer collection system may run in the rear of the residence; however, areas of responsibility remain the same. The 4" customer lateral may in some areas also extend into the County easement.

## 05.04 Document Retention

Under the CD, the County is required to maintain all records documenting the steps taken, and which will be taken, to prevent the SSO from recurring. These records are to be maintained for a period of not less than 5 years. Specifically, the required records include:

- EAMS work order records;
- EPA, RER-DERM, and FDEP reports and forms;
- Water quality sampling results; and

- Building Backup and claims documentation.

These materials will be retained and stored under MDWASD records management archival and retention protocols for electronic and paper documents and records.

THIS PAGE LEFT INTENTIONALLY BLANK



## 06. SSO and Building Backup Response

MDWASD has developed extensive plans to mobilize labor, materials, tools, and equipment to correct or repair any condition that may cause or contribute to an unpermitted discharge. Table 06.1 provides an overview of the emergency response plan elements, the MDWASD staff responsible for each element, and the MDWASD manager responsible for authorizing implementation of each element. As noted in the following sections, these roles may be delegated depending on the magnitude and the potential impact of the spill event.

**Table 06.1**  
**Emergency Response Plan Element Overview and Staff Responsibility**

Plan Element	Action By <sup>1</sup>	Authorized By
Mobilize Emergency Response Team	Response Manager	Assistant Director
Mobilize Contractor (Optional) <sup>2</sup>	Operations Engineer or Unit Supervisor	Response Manager
Implement Logistics Plan	Logistics Officer	Response Manager
Initiate Flow Control Measures	Unit Supervisors	Response Manager
Implement Flow Control Measures	Unit Labor Crews	Operations Engineer
Obtain Emergency Permits	Liaison Office	Response Manager
Monitor Safety	Safety Officer	Response Manager
Disseminate Information	Communications Officer	Response Manager
Cleanup SSO Sites	Unit Labor Crews	Operations Engineer
Cleanup Building Backups	Contract Vendor	Liability Claims

<sup>1</sup> Authority is delegated to Unit Supervisors for response to smaller spill events that have minimal volume and do not endanger public health or the environment.

<sup>2</sup> Circumstances may arise when MDWASD relies on the support of private-sector construction assistance. This is particularly true in cases such as large pipes buried to such depths as may require sheet piling and dewatering or aerial force main canal crossings that require heavy equipment that is not owned by the maintenance or repair units. These non-standard operations would best be handled by skilled, heavy construction contractors on MDWASD's list of pre-approved emergency contractors.

Subsections 06.01 through 06.06, respectively, describe the emergency response protocols, the control measures, the cleanup procedures, water quality monitoring, water quality analyses, and follow up measures for SSO events.

## 06.01 Emergency Response Protocols

As detailed in Section 05, SSO Reporting and Notification, MDWASD's FIC responding to potential SSO incidents reported to the Communications Center assess the problem and report back to the Communications Center immediately upon verification of a wastewater release or discharge. The responding Supervisor from the WWCTLD or PSD, as applicable, is responsible for dispatching additional response crews, if needed, and providing initial SSO data to the Communications Center, preferably within two hours, for initial SSO reporting. In some cases, all required information may not be available within two hours; however, it will be provided as soon as it can be determined without interfering with the primary mission of the responding crew to stop the overflow. The Communications Center notifies RER-DERM and then initiates a Wastewater Discharge/Abnormal Event Notification form. If the event is expected to exceed 1,000 gallons, additional public and agency notification protocols are initiated.

### 06.01.1 SSO Emergency Response Protocols

The Response Administration System is patterned after the Incident Command System developed by the National Fire Academy. The latter is the standard communication system for fire departments in the United States, and was selected by OSHA as the organizational structure for responding to chemical spill emergencies. In addition, the Superfund Amendments and Reauthorization Act of 1966 (SARA) requires organizations that handle hazardous material incidents to operate with an incident command system.

The Response Administration System is intended to ensure responsible, overall management of a serious incident and to accomplish the repair promptly. Other functions include logistics support, site safety, agency liaison, and information systems. Most MDWASD SSOs are small spills that are usually contained and do not reach receiving waters. In those cases, the Response Administration System is streamlined and simplified with the responding supervisor assuming logistics support, site safety, and information systems roles. Agency liaison is continued to be handled by the Regulatory Compliance Section office personnel supported by the Communications Center liaison with field staff. Serious incidents are considered those where the spill cannot be stopped during the same shift or where the spill threatens public health or the environment.

Emergency response to a report of a SSO is coordinated by the Response Manager, which is the Deputy Director of Operations, assisted by the Assistant Director of Wastewater Operations, the WWTMD Chief, the WWCTLD Chief, and the PSD Chief. For routine spills, these roles have been delegated to Unit Supervisors who are responsible for escalating response decision-making should the magnitude or the potential impact of the spill so require.

Immediate actions consist of stopping the spill in a safe manner, internal notifications, repair, and cleanup. Emergency permitting, if necessary, will follow subsequent to the repair action.

Depending on the system asset that is suspected to be the cause of the SSO, the Unit Supervisor responsible for implementation of the response plan is the supervisor responsible for that asset. When needed, other Unit Supervisors will assume associated leadership roles to ensure that temporary bypasses, inter-district diversions, and emergency flow controls are implemented.

Upon receiving notice of a possible unpermitted discharge from the Communications Center, the Unit Supervisor notifies the other Unit Supervisors of a potential need to mobilize their respective operations staff to implement appropriate controls. Two FICs are available during normal working hours and one FIC is available during non-working hours.

Next, the Unit Supervisor confirms that the FIC has already been dispatched to the site by the Communications Center and prepares to mobilize additional field crews to the site once the FIC verifies an SSO. The FIC assesses the problem and, by mobile communication, reports the findings back to the Unit Supervisor. Based on the type and extent of the SSO, the Unit Supervisor establishes and implements a plan to control and correct the spill. In most cases, the SSO is typical of prior incidents that the supervisors and crews have effectively controlled many times in the past and the response plan is merely adapted to the particular asset and geography of the current spill.

MDWASD work crews and equipment are stationed at various locations depending on the division (e.g., WWCTLD or PSD). WWCTLD is typically the first responder division and has crews at:

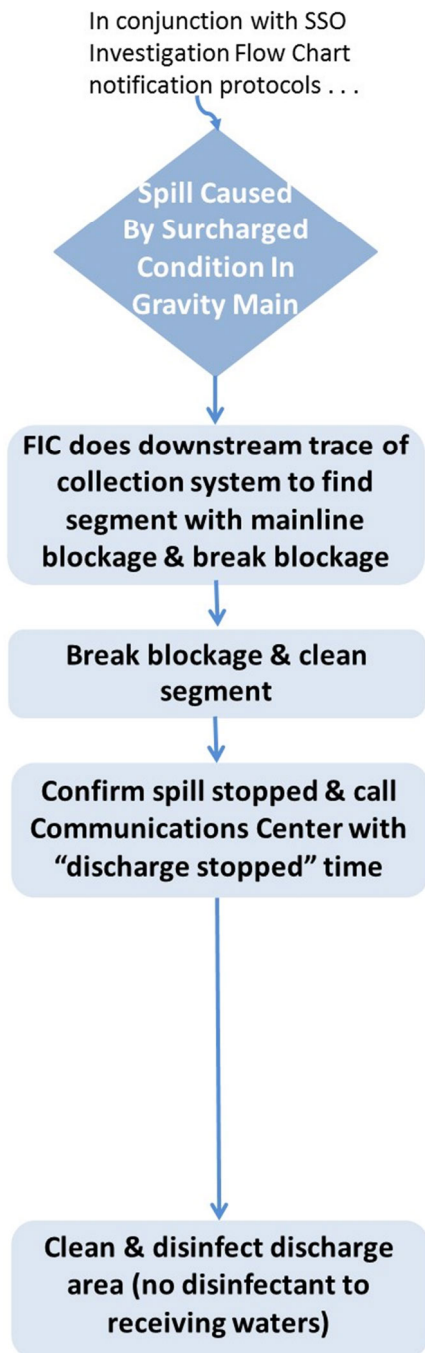
- North: Carol City Facility,
- Central: 36<sup>th</sup> Street Facility, and
- South: South Miami Heights Facility.

The PSD has workshops for each of PSD's four sections at Westwood Lakes, 36<sup>th</sup> Street, and South Miami Heights Maintenance Yards and at the North District WWTP. The Westwood Lakes facility was built exclusively for pump station operations, but now houses other divisions and groups.

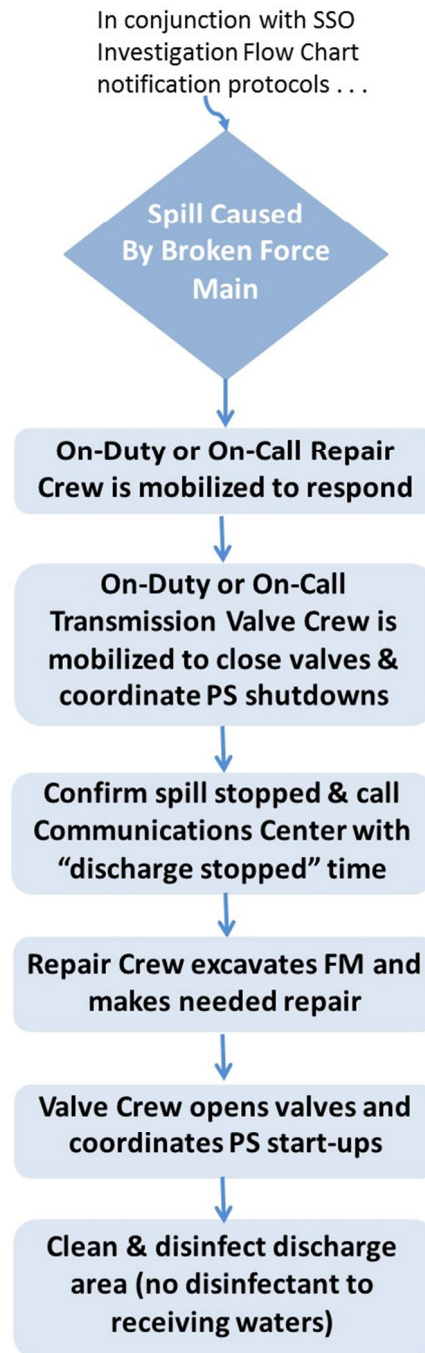
Upon arriving at the site, a three-fold plan is implemented in parallel steps by the responding team members. First, the supervisor and crews from the responding division implement shutdown plans to divert flow from the affected area if a force main or gravity transmission main is involved or if upstream pump stations are expected to pump flow to the area. Second, the supervisor and crews establish safe working conditions and work to stop the overflow as rapidly as possible. As needed, the supervisor and crew(s) utilize the assistance of the Liaison Officer and Miami-Dade or local police to ensure people are kept away from emergency work sites. Third, the supervisor and crews begin to contain the spill area and minimize the release of sewage to populated areas and surface waters (including storm drains that lead to water bodies). The common purpose of these actions is to protect the public from harm and from any long-term effects resulting from a spill.

For the most common types of SSO events, MDWASD has developed flow charts illustrating the SSO field crew response activities. Figures 6.1 through 6.4 present the flow charts for gravity main-related SSOs, force main-related SSOs, air relief valve-related SSOs, and SSOs at pump stations. These response activities should be completed in parallel or immediately following verification of the SSO event to the Communications Center so the appropriate incident reporting and notification protocols are implemented.

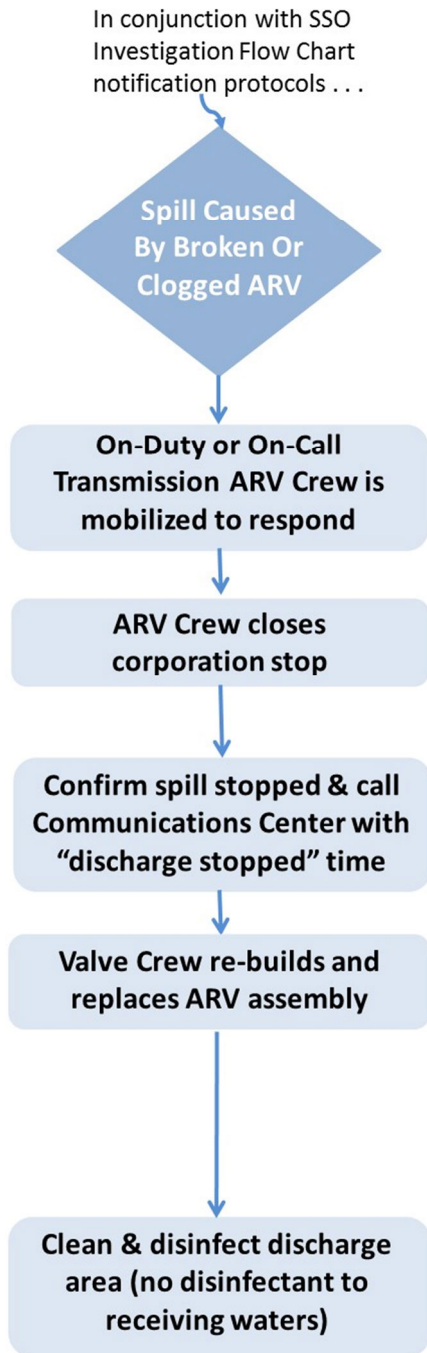
**Figure 06.1**  
**Gravity Main SSO Field Response**



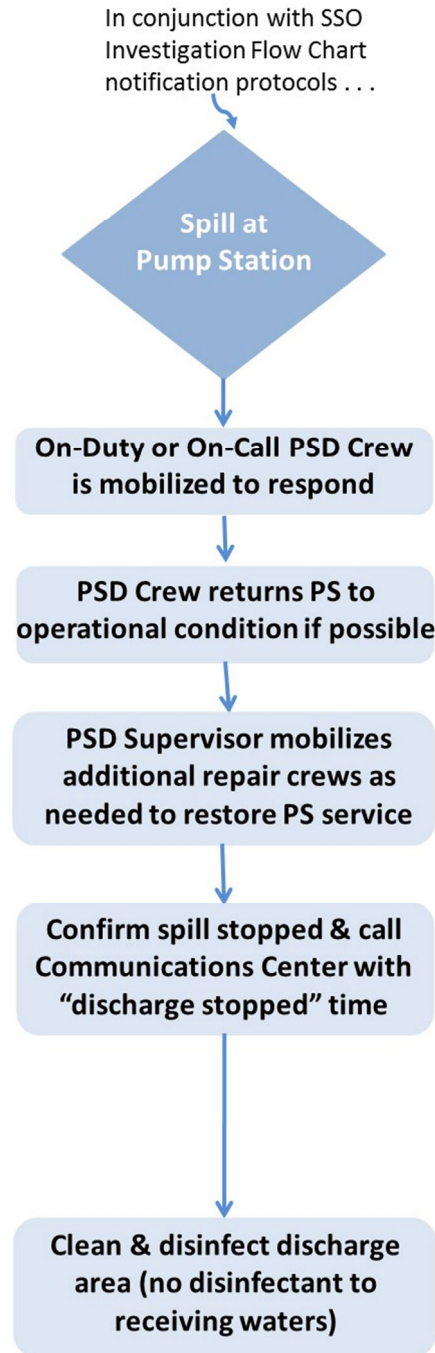
**Figure 06.2**  
**Force Main SSO Field Response**



**Figure 06.3**  
**Air Relief Valve SSO Field Response**



**Figure 06.4**  
**Pump Station SSO Field Response**



Subsequent to these immediate actions and the repair activities illustrated in Figures 6.1 through 6.4 for the most common types of SSO events, MDWASD and/or contractor forces

correct the failure and begin cleaning and disinfection actions as detailed in Subsection 06.03, Cleanup Procedures.

### 06.01.2 Building Backup Emergency Response Protocols

As with the SSO emergency response protocols, MDWASD's Building Backup emergency response protocols start with the Communications Center, which follows a script to determine, at least on an initial basis, that it is a MDWASD-caused problem and not a private problem, and to explain MDWASD's billing process. Since the customer is responsible for repair and maintenance of the private lateral and for keeping the public lateral free of obstructions, the customer is responsible for calling a plumber to resolve those issues. If the customer calls a plumber who correctly determines the issue was a public sewer issue or required public lateral repair, MDWASD repairs the public lateral and ISD-RM reimburses the customer for all reasonable plumbers' fees associated with identifying the lateral repair need. MDWASD bills the customer for service calls that are determined to be in the customer's area of responsibility (i.e., private lateral problems or public lateral obstructions not caused by a needed public lateral repair).

Building Backup emergency response follows the same protocols as the SSO emergency response after it is determined that the event is a Public Building Backup rather than a Private Building Backup in accordance with the Communications Center scripts as described in Subsection 05.03.4, Building Backups. When the cause is determined to be on the private lateral or the building plumbing, the Communications Center (or the FIC Supervisor if the FIC is already on-site) advises the customer to call a plumber. As a customer service, the FIC also provides the customer with a Private Building Backup fact sheet that includes guidance on cleaning up the sewage and preventing future incidents. Appendix F, Sewage Backup Prevention Fact Sheet, contains a copy of the fact sheet.

For Public Building Backups, once the field crews have returned the system to normal operations, the Unit Supervisor contacts the Liability Claims Administration Section to initiate cleanup activities. Liability Claims Administration Section personnel are responsible for authorizing MDWASD's contract vendor to complete their cleanup and disinfection procedures as defined in Subsection 06.03.2, Building Backup Cleanup.

## 06.02 SSO Control

Under most circumstances, MDWASD handles all response actions with its own maintenance forces. These personnel have the skill and experience to respond rapidly and in the most appropriate manner. An important issue with respect to an emergency response is to ensure that the temporary actions necessary to stop or shutdown flows and fix the problem do not produce a problem elsewhere in the system. For example, repair of a force main would require closure of the pipe and diversion of the flow at an upstream location. If the closure is not handled properly, wastewater system backups could create other spills. MDWASD crews, with their knowledge of the system, can address these problems best. For the larger gravity mains and the force mains requiring a sequencing of shutdown activities, the WWCTLD has developed shutdown plans to ensure proper flow diversion. The typical SSO control measures for flow diversion, wastewater pipes, pump stations, and treatment plants are summarized below.

### 06.02.1 Flow Diversion and Environmental Precautions

When sewage is overflowing from manholes, cleanouts, wet wells, or failed pipes, the FIC and field crews are directed to immediately divert sewage away from any nearby water body or from any storm drain or catch basin inlet that leads to receiving waters in accordance with the following procedures:

1. Maintain a safe working environment that minimizes the potential for sewage contact by the public or customers.
2. Restore normal flow conditions as soon as possible.
3. Place sand bags or flow barriers such as earthen berms around storm drain inlets, catch basins, or drainage ditches to prevent sewage from discharging into adjacent water bodies.
4. Under the occasional events where normal flow conditions cannot be restored promptly:
  - a. Install temporary bypass pumping (see Subsection 06.02,3, Pump Stations, for bypass pumping details) if normal flow conditions cannot be restored promptly.
  - b. Consider communicating with the public and upstream industrial customers to conserve water and limit waste generation during emergency periods.



- c. Minimize the volume of sewage transmitted to any portion of the WCTS impacted by the spill by such measures as:
  - i. Shutting down upstream pump station(s) on a temporary basis to store wastewater flow in the upstream collection system and wet wells while repair is effected.
  - ii. Activating regional or booster pump station and/or force main valves to divert wastewater to another portion of the WTCS if needed.
5. Vacuum up or otherwise recover as much sewage as possible, including any impacted drainage systems.
6. Implement site cleanup and disinfection procedures (do not disinfect receiving waters) upon completion of the repair activities.

Prior to emergency repair work, response personnel are advised of precautions to minimize adverse environmental impacts, as follows:

1. All personnel working adjacent to Biscayne Bay and on Virginia Key should know the boundaries of the Critical Wildlife Area, its significance to manatee preservation, and its no entry designation. Access to the Critical Wildlife Area shall be limited to the greatest extent possible.
2. Repair crews should take all necessary precautions to prevent construction debris from falling into surface waters. Any debris that falls into the water shall be removed immediately.
3. Effective turbidity control, such as, but not limited to, turbidity curtains, shall be employed during all operations that may create turbidity. If necessary, turbidity curtains may be extended to enclose the entire work area. Where water depths and currents allow, turbidity curtains shall be weighted sufficient to extend to the entire depth, but only in cases where sea grasses will not be damaged. All curtains shall remain in place until turbidity levels have subsided.
4. All excess spoil generated from the excavation shall be removed from the work area and disposed of in accordance with applicable federal, state, and local regulations.

5. If historical or archaeological artifacts, such as Indian canoes, are discovered at any time within the project site, MDWASD should immediately notify the FDEP and the Bureau of Historic Preservation, Division of Archives, History and Records Management, R.A. Gray Building, Tallahassee, FL 32301.

In addition to regulatory agency SSO notifications detailed in this SORP, several agencies require emergency permitting before, during, and after an emergency response. Many of the federal, state, and local agency requirements may be fulfilled by contacting the agencies and describing the location and extent of the incident. After-the-fact permits are required, on a case-by-case basis, by RER-DERM and FDEP for permanent repair work. If work affects streets and roads, the local department of public works and the Florida Department of Transportation should be contacted. Table 06.2 summarizes the agencies and the associated requirements and concerns relating to obtaining emergency regulatory authorization.

**Table 06.2**  
**Agency Contacts for Emergency Response Permitting/Authorization**

Agency	Requirement	Concerns	Staff Contact
U.S. EPA, Region IV	Contact	Compliance with 2014 Consent Decree	Brad Ammons (404) 562-9769
U.S. Coast Guard, Captain of the Port	Contact	Compliance with marine vessel safety regulations	(305) 415-6670
U.S. Army Corps of Engineers, Miami Permitting Section	Contact	Permit by Rule applicable in emergency situations	Paul Kruger (305) 526-7181
Florida Department of Environmental Protection	Permit after the fact	Permit required for permanent repairs on a case-by-case basis	Jason Andreotta (561) 681-6639
Miami-Dade County RER-DERM	Permit after the fact	Permit required for permanent repairs on a case-by-case basis	Carlos Hernandez (305) 372-6714
Florida Department of Health and Rehabilitative Services	Permit after the fact	Permit required for permanent repairs on a case-by-case basis	Samir Elmir (305) 623-3500
South Florida Water Management District	Contact	Impacts to management of surface waters	24/7 Operations Control Center (561) 682-6116

## 06.02.2 Wastewater Pipes

Wastewater pipes that suffer clogs and blockages are identified by observing manhole surcharge conditions. When the blockage location is identified, MDWASD sewer cleaning crews respond to break the blockage and restore normal sewage flow conditions as soon as possible to alleviate surcharging and sewage backups as indicated by the flow response activities in the flow chart in Figure 06.1 above. The cleaning crews utilize vacuum trucks to vacuum and remove the sewage and the obstructing materials at the downstream manhole to prevent the materials from moving downstream and contributing to a future blockage.

Wastewater pipes, both gravity sewer and force main pipes, that suffer failures and produce an SSO are replaced in kind. Actions required include measures to prevent flow to the affected section while the repairs are being made. Flow through larger force mains and interceptors are diverted within the system to the maximum extent possible. Smaller pipe failures are generally handled by shutting down upstream pump stations and plugging pipes. Small force main breaks are often handled by shutting down the upstream pump station(s) for the relatively short time required to effect the force main repair and temporarily using upstream storage capacity.

Temporary bypass lines carry flow from the nearest manhole upstream of the failure to the next downstream manhole. If necessary, influent wastewater at the upstream manhole will be lifted to the surface using portable pumps and generators. Work crews block the ends of the section under repair to prevent inflow. Pipe repair operations then proceed using standard construction methods. Mobile bypass pumps are used to bypass flow when necessary.

Additional information on the WWCTLD O&M activities to eliminate, reduce, prevent, or otherwise control SSOs is contained in MDWASD's *Gravity Sewer System Operations and Maintenance Program (GSSOMP)* and *Force Main Operations, Preventative Maintenance, and Assessment / Rehabilitation Program (FMOPMARP)*.

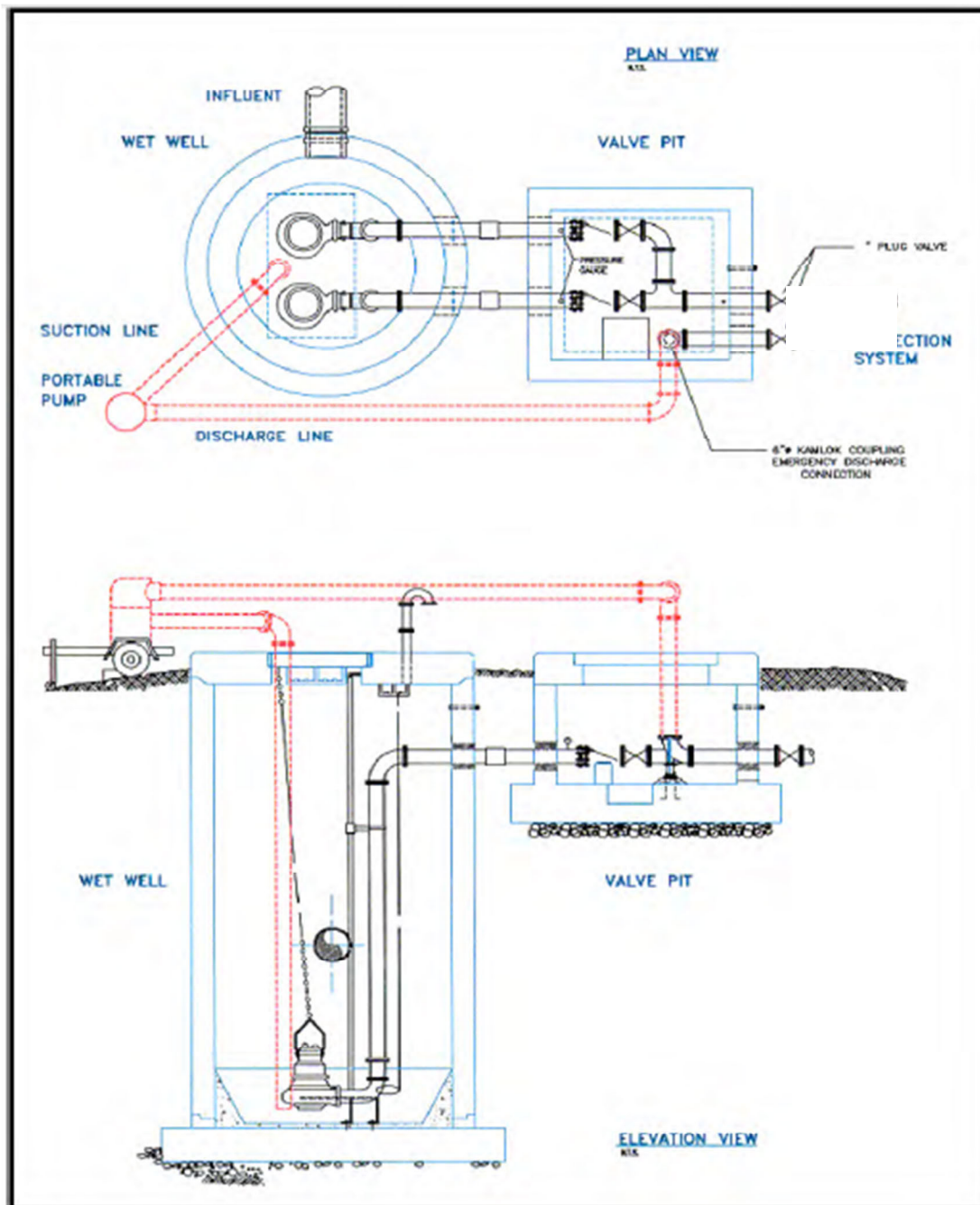
## 06.02.3 Pump Stations

As with pipe-related problems, PSD crews responding to pump station emergencies have a top priority to return the station to normal flow conditions. This applies to all types of pump station

emergencies, including electrical, mechanical, and structural issues. The type of SSO control applied during a specific SSO event will therefore vary depending on the nature of the pump station failure. The flow chart in Figure 06.4 above illustrates the overall field response activities to return the station to operational condition. The activities required to return the station to operational condition essentially constitute a root cause analysis to determine the type of repair required.

When a pump station suffers a failure, temporary bypass pumping using portable pumps, piping, and/or generators is installed. When in bypass, the influent to the wet well is pumped to the surface and delivered through a valve connection in the pump station discharge line. Figure 06.5 is a schematic showing a typical bypass pumping installation.

**Figure 06.5**  
**Wastewater Pump Station Bypass Schematic**



Pump Station 187 (also referred to as No. 33-P1) is located near the intersection of West Flagler Street and Northwest Boulevard and provides the flexibility to divert some flow to any of the three service districts.

Several pipe loops exist within MDWASD's service area, but the collection network is not completely redundant. MDWASD is continually designing and adding bypasses to the system to increase its capacity to reroute flows as necessity dictates.

When possible, the quantity of wastewater discharged will be minimized by manipulating flow control devices to reroute flow through other pipelines. In instances where the notification plan is activated and flow reductions are necessary, MDWASD encourages temporary reductions among its customers.

Additional information on PSD O&M activities to eliminate, reduce, prevent, or otherwise control SSOs is contained in MDWASD's *Pump Station Operations and Preventative Maintenance Program* (PSOPMP).

#### 06.02.4 Treatment Plants

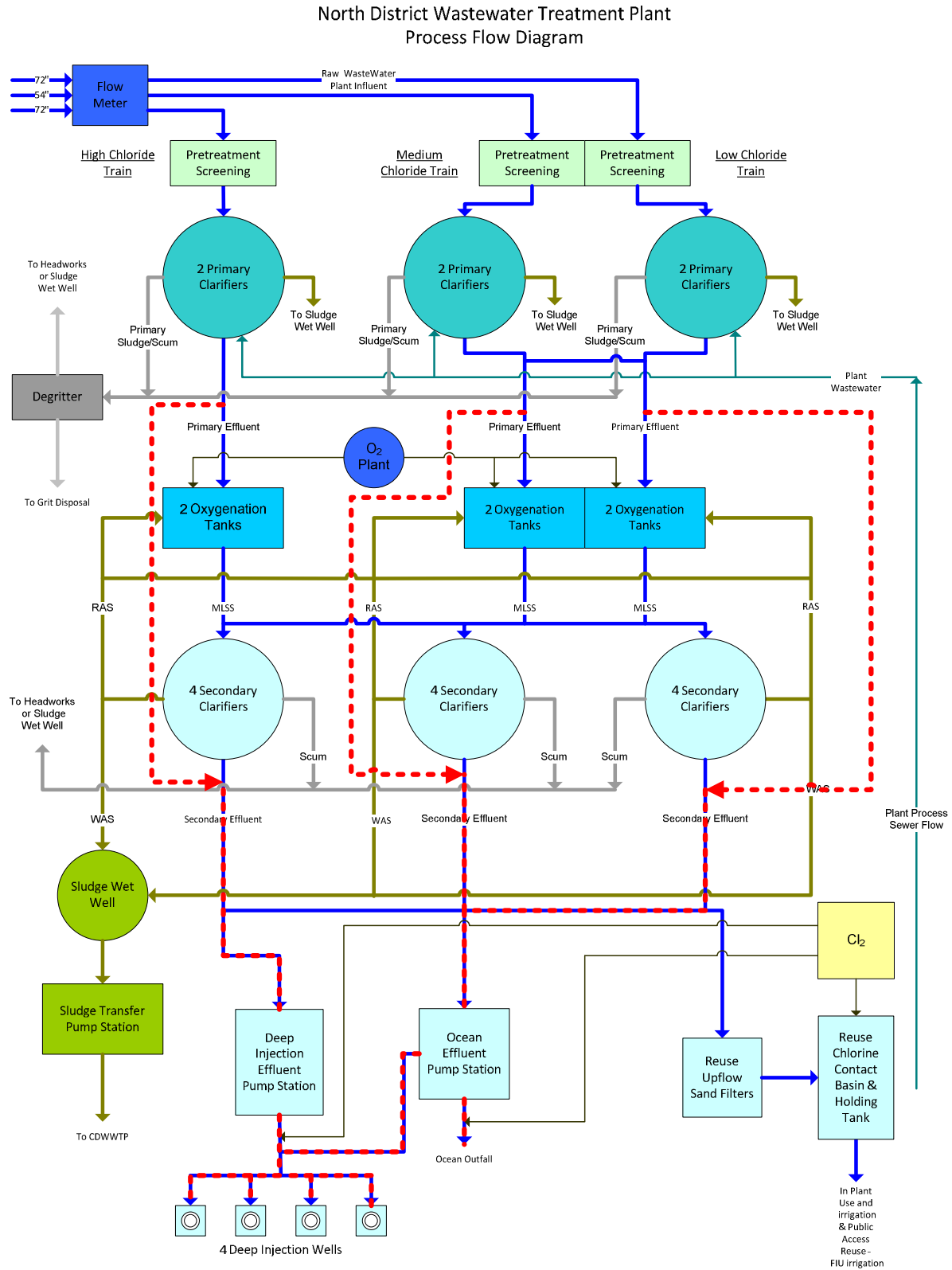
SSO events at the treatment plant sites can be either influent sewer, influent pump station, or influent force main failures. Other unpermitted discharges of partially treated sewage from the plant process units or piping are not considered SSOs, but are spills subject to reporting under the terms of the applicable NPDES Permit and under RER-DERM and FDEP regulations. WWTMD staff respond to the influent pipe or pump station failures in a similar manner to the activities described above for WWCTLD and PSD. Discharges of partially treated sewage from the process units are primarily responded to by finding the source(s) of the leaks or overflows and eliminating the problem, cleaning up the site by removing as much sewage as possible, and disinfecting the spill site.

In the event of an emergency at the North District WWTP (NDWWTP), all or a portion of the influent can be diverted around the process units through an 84-inch bypass pipe. This pipe carries flow to the effluent outfall chamber for mixing and disposal with treated effluent or for direct disposal. In the event of an emergency at the Central District WWTP (CDWWTP), one of the two parallel treatment trains at the CDWWTP contains an emergency bypass pipe. This line carries influent from the discharge ends of the grit chamber to the effluent outfall pumping station by gravity flow. In the event of an emergency at the South District WWTP (SDWWTP),

excess flow can be diverted to several interconnected percolation ponds having a total exfiltration capacity of 75 mgd.

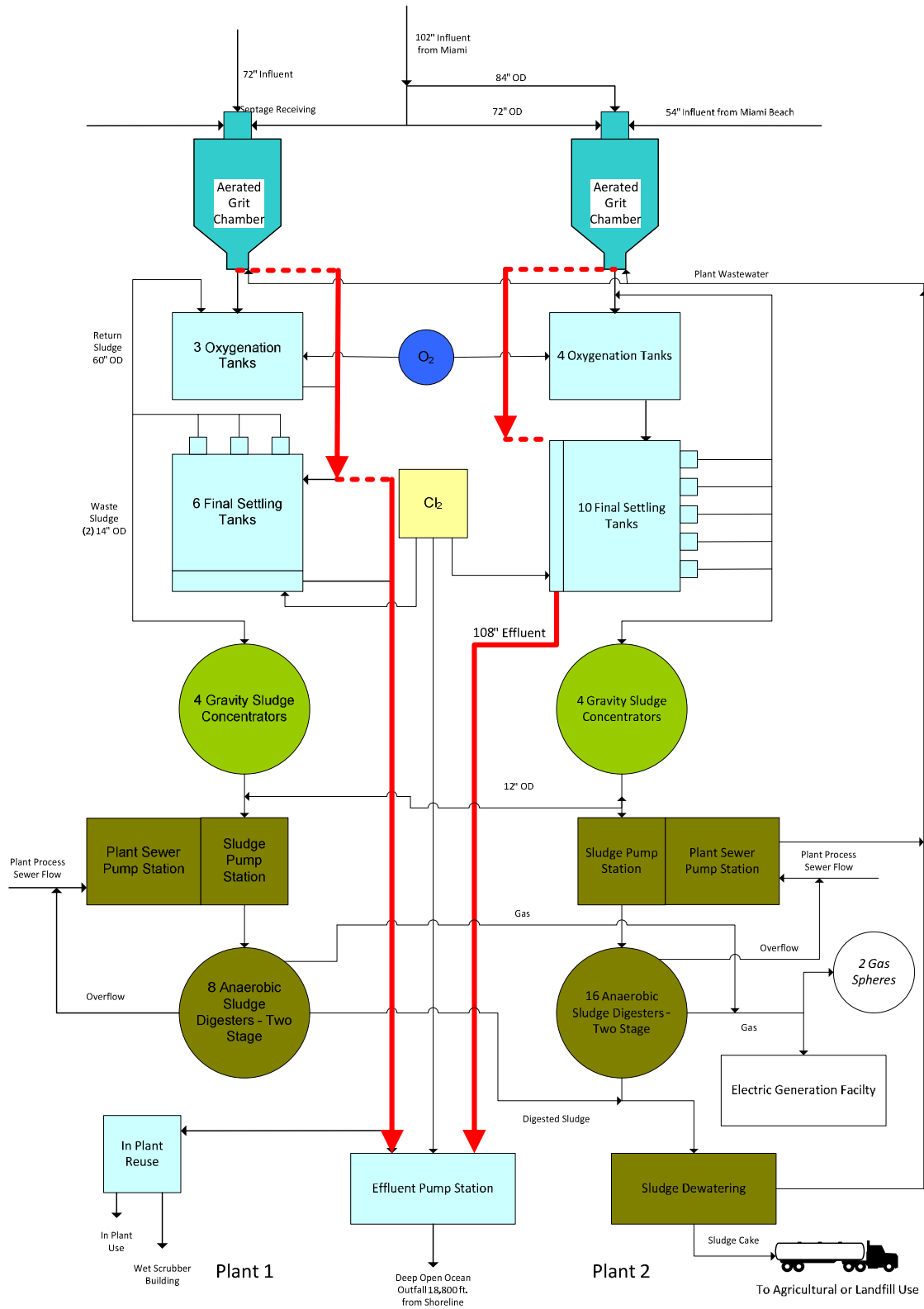
Figures 06.6, 06.7, and 06.8 illustrate the plant bypass schemes at the NDWWTP, the CDWWTP, and the SDWWTP, respectively. The bypass lines are shown in red in each of the process flow schematics.

**Figure 06.6**  
**NDWWTP Bypass Scheme**

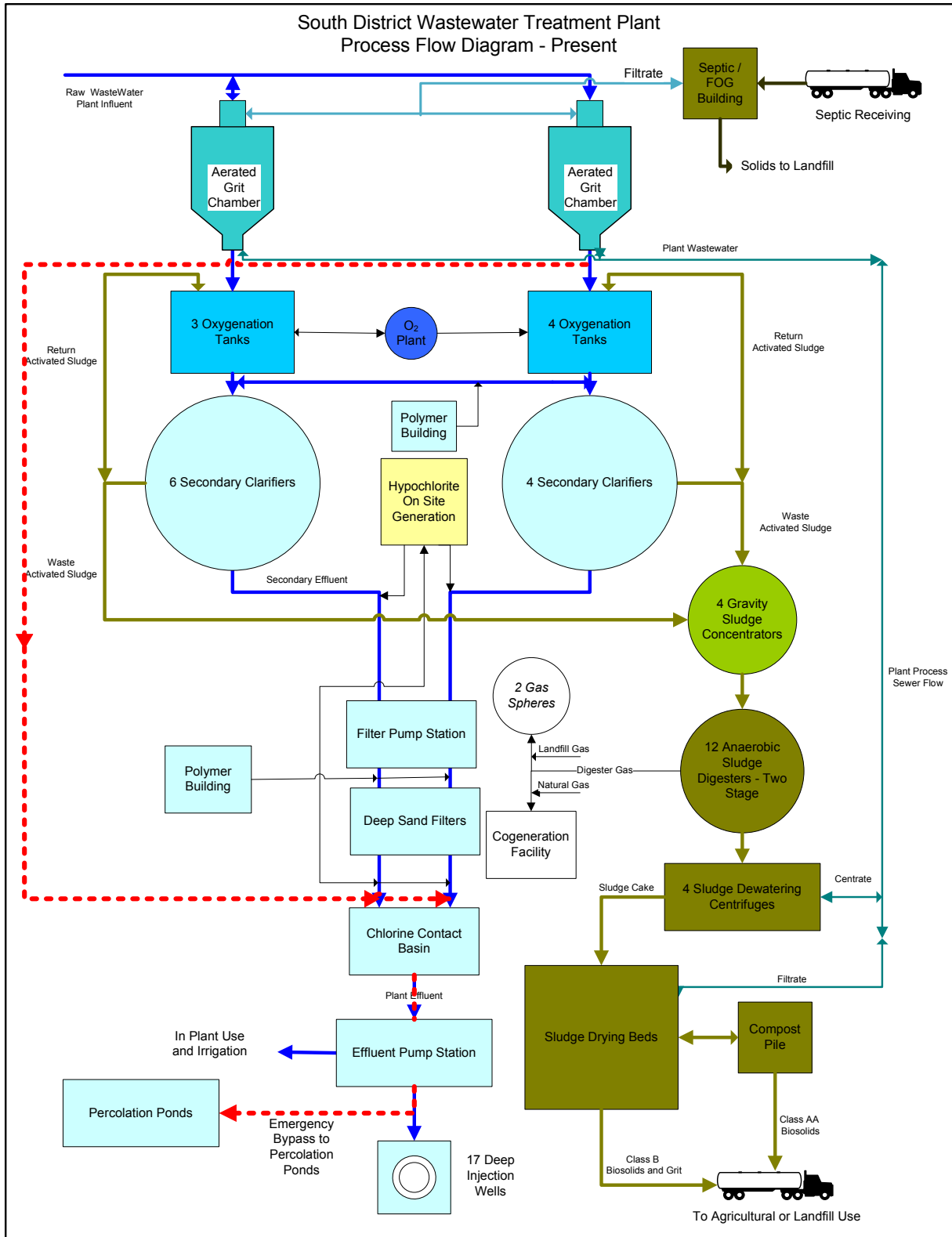




**Figure 06.7**  
**CDWWTP Bypass Scheme**

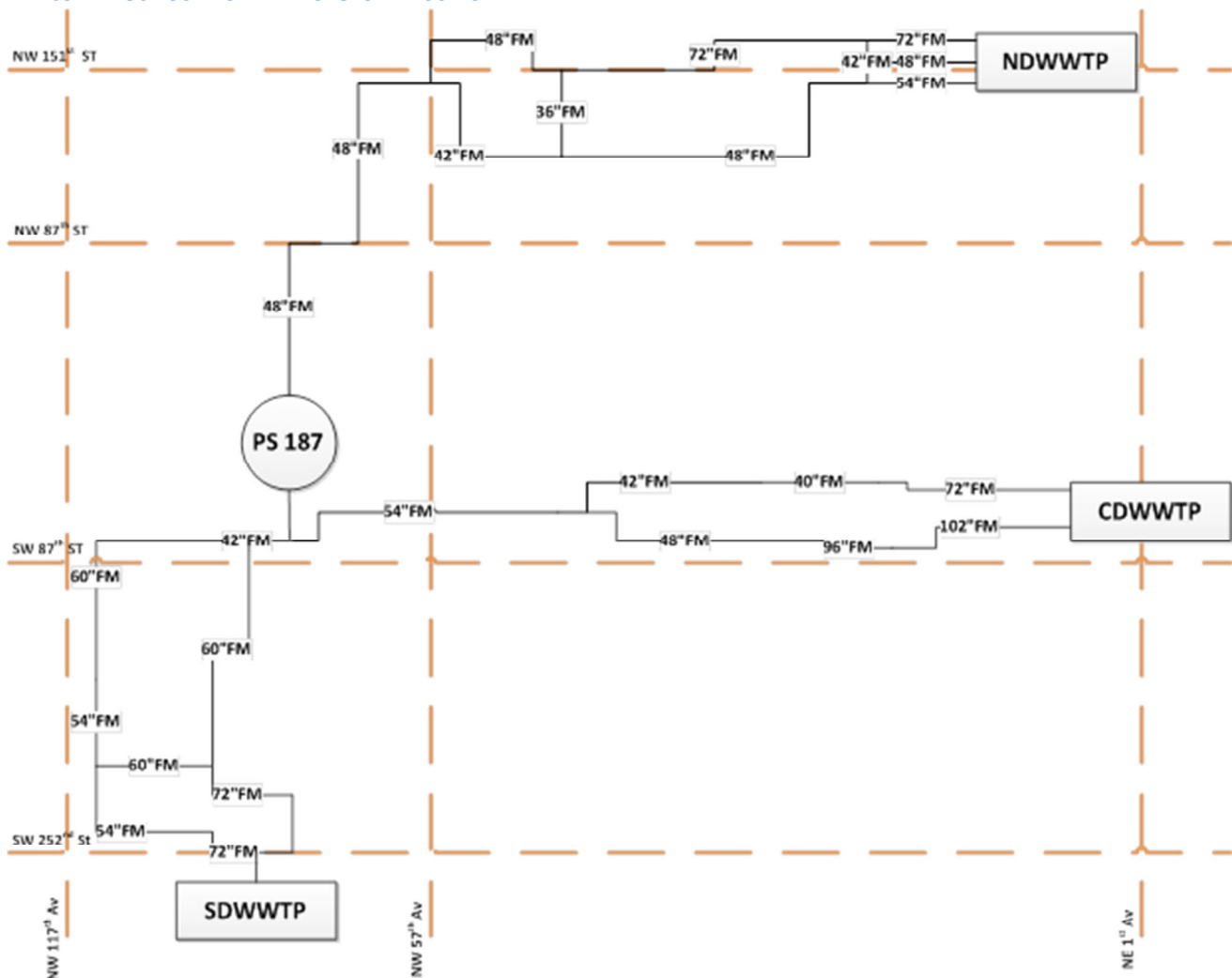


**Figure 06.8**  
**SDWWTP Bypass Scheme**

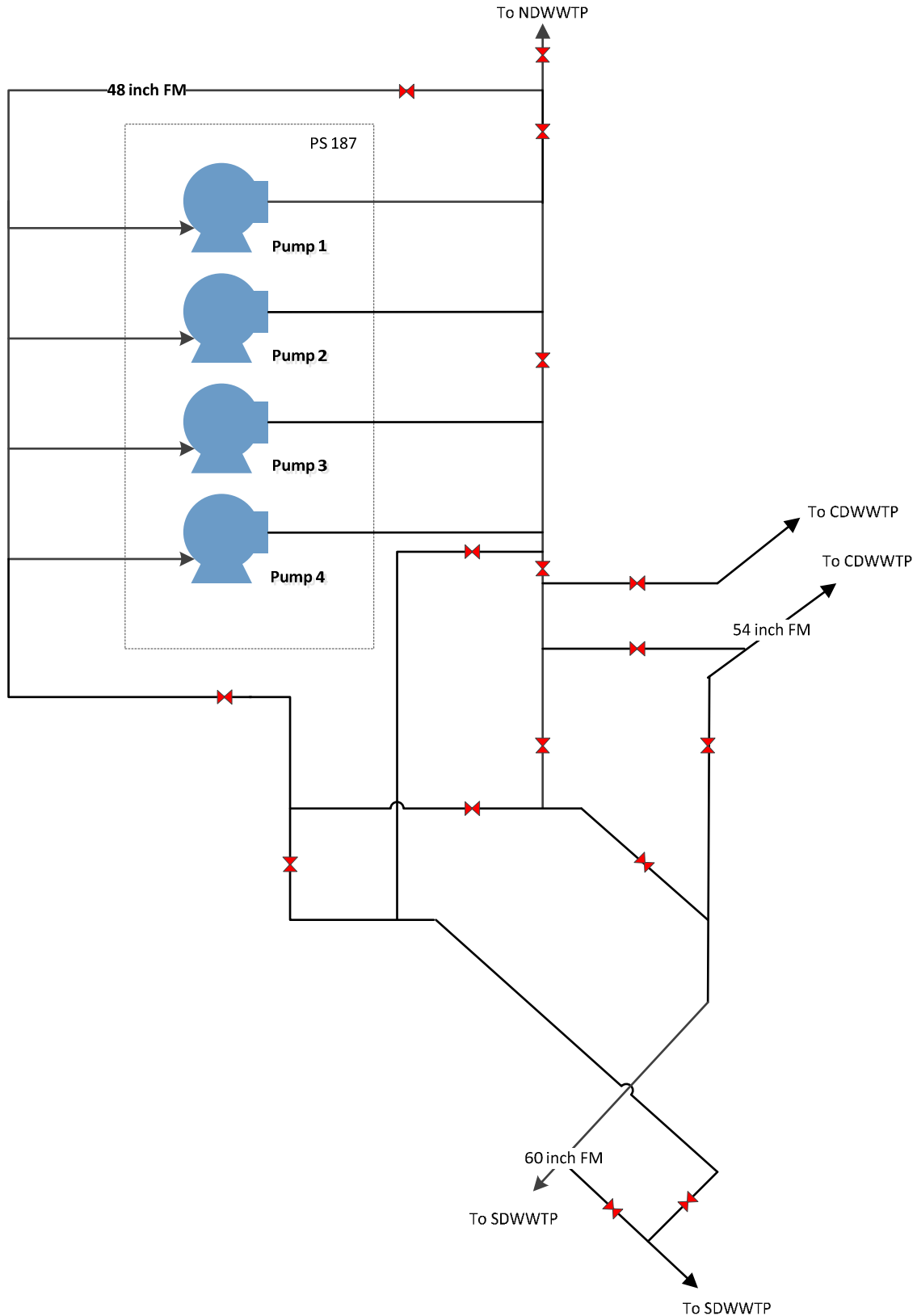


In the event that an SSO occurs in a major force main or interceptor that transmits flow to one of the three regional treatment plants, MDWASD can divert portions of the wastewater to another region. The focal point for diversion among the regions is Pump Station 187, which MDWASD constructed in 1987 to provide a means of proportioning flow among the districts in order to maximize treatment levels. This station has a capacity of approximately 25 mgd and has been upgraded to include header piping to allow for more versatility in diverting flows. Valves can be manipulated to direct flow between districts. Figure 06.9 is a schematic of the vital force mains through which flow is directed to each of the three districts. The potential operating positions of the flow control valves at Pump Station 187 are illustrated in Figure 06.10.

**Figure 06.9**  
**Inter-District Flow Diversion Network**



**Figure 06.10**  
**Flow Control at Pump Station 187**



The choice of which plant(s) to divert flow to/from is made by the Assistant Director for Wastewater System Operations and the PSD Chief. The decision is made in consideration of the current inflow rate at each plant and the capacities to accept greater flows without adverse treatment consequences. In the instance in which the alternative plants are being operated at or near capacity, flow will be sent to the NDWWTP or the CDWWTP since those plants have the greatest treatment and disposal capacity. The SDWWTP is limited by its permitted capacity to discharge flow through its deep well injection system.

Flow diversion will be made regardless of whether the alternate plants are being operated at or above their treatment capacities. While increased quantity of flow may detract from the overall treatment efficiency, substandard treatment and disinfection is superior to a direct discharge of wastewater.

In certain instances, MDWASD may take advantage of lagoons (i.e., percolation ponds) at the SDWWTP for disposal. The ponds have an average total capacity of 75 MG with percolation extending this capacity. However, there is no ability to return wastewater from the ponds back to the plant for treatment.

Whenever plant O&M personnel need to take a significant process unit out-of-service for maintenance or repair, EPA/FDEP shall be notified of the need to bypass that treatment unit(s). Potential failures of other process units from the unexpected impact of a large storm event during the planned bypass period could cause, or increase the volume of, SSO events at or near the plant site. Prior agency notification of these events is crucial.

Additional information on WWTMD O&M activities to eliminate, reduce, prevent, or otherwise control SSOs, plant bypasses, and effluent discharges is contained in MDWASD's *Wastewater Treatment Plant Operations and Maintenance Program (WWTP OMP)*.

### 06.03 Cleanup Procedures

SSO cleanup procedures are defined in Subsection 06.03.1, SSO Cleanup, and Building Backup cleanup procedures are defined in Subsection 06.03.2, Building Backup Cleanup.

### 06.03.1 SSO Cleanup

Spills to surface waters are contained and removed by either WWCTLD, PSD, or WWTMD personnel to the greatest possible extent. As the problem is being corrected, or immediately thereafter, MDWASD begins to clean and disinfect areas impacted by the spill. The cleanup and disinfection procedures are:

1. Maintain the safe working environment that minimizes the potential for sewage contact by the public or customers throughout the spill cleanup activities.
2. Recover and remove spilled sewage when possible using MDWASD vacuum trucks or larger tank trucks. A large fleet of 2,000-gallon vacuum trucks and 6,000-gallon tank trucks are available to collect spilled wastewater and deliver it to one of the WWTPs for disposal. Where capacity exists, trucks may dispose of spilled wastewater into a downstream WCTS manhole. This option is best used for larger spills where the option can greatly increase the capability of a limited number of hauling vehicles.
3. Rake and remove sewage debris that cannot be removed by vacuum or tank trucks.
4. Apply slaked lime to disinfect surface areas where the spill has been removed. (Do not use disinfectant where it might be washed into surface waters.)
5. Post warning signs in accordance with RER-DERM instructions if receiving water has been impacted.
6. Subsequently, return to promptly remove warning signs upon RER-DERM and/or Miami-Dade Department of Health authorization.

## 06.03.2 Building Backup Cleanup

MDWASD contracts with a cleanup contractor to clean and disinfect customers' homes and businesses should a MDWASD-caused Public Building Backup occur (or as a customer service should a "splash" event occur during a public sewer cleaning operation). The current contractor is Steam Master Cleaning Services. Steam Master follows these cleaning and disinfection procedures:

1. After the service call is received to provide cleaning and disinfection following a sewage backup, Steam Master contacts the responsible party and gives instructions not to touch anything that has been in contact with sewage and to stay away from the affected areas.
2. Upon arrival, Steam Master assesses the damage and takes pictures.
3. All personal belongings that have been in contact with the sewage are placed in plastic bags for proper disposal.
4. The affected areas are sprayed with a pressure steam gun and a solution of Simple Green D Pro 3®, which is an EPA-registered, one-step hospital-grade germicidal cleaner. At the same time, the water and sewage is extracted. This mixture of high temperature with antibacterial and deodorizer has proven to be effective to kill the bacteria that could be found in sewage compared to chlorine, which some bacteria have become resistant (such as Cryptosporidiosis).
5. After all the affected areas are sprayed and all the sewage is extracted, a complete rinse is done with hot water and pressure between 700 and 1,000 pounds per square inch (psi). All elements in which water pressure cannot be applied are cleaned and disinfected by applying Simple Green D Pro 3® with a hand sprayer and rinsed out with fresh hot water.
6. After all the affected areas are cleaned and disinfected, and the floors dried or disposed of (e.g., carpet or laminate flooring), the last step is treatment with a fogging (wet) machine and Microban®, which is an antimicrobial product protection suitable for a breadth of materials including polymers, textiles, coating, paper, and adhesives. The Microban® fogging treatment is crucial due to the different viruses that can be found in sewage, such as Rotavirus, Adenoviruses, and Norovirus. The fogging treatment with

Microban® guarantees to be effective to kill all the viruses when applied following manufacturing instructions.

Steam Master has served MDWASD, the City of North Miami Beach, and private industry for more than 20 years and has not had a single case of someone getting sick due to a virus or bacteria after providing their services.

Steam Master responds promptly to schedule cleanup with each customer. MDWASD is typically able to respond to a customer complaint of a possible Building Backup within 60 to 90 minutes. Once the FIC confirms a Public Building Backup, the cleanup contractor is able to respond within another 60 to 90 minutes and, if site access is authorized by the customer, initiates cleanup immediately upon arrival at the site. Cleanup is normally completed the same day. However, there are times when the customer prefers to schedule cleanup for a later time and those requests are accommodated by the cleanup contractor. Upon completion of the cleanup, the customer is asked to sign a form indicating the cleanup was performed to the customer's satisfaction to ensure the adequacy of the cleanup.

## 06.04 Water Quality Monitoring

Water quality monitoring is conducted by RER-DERM when the SSO volume exceeds the 1,000-gallon threshold and the flow from the release impacts surface waters directly (direct discharge to receiving water) or indirectly (indirect discharge to receiving water through a storm drain, catch basin, or drainage ditch). RER-DERM sampling activities are coordinated by the RER-DERM Natural Resources Division with backup support provided by the RER-DERM Pollution Regulation Division. The Pollution Regulation Division also coordinates after-hours and weekend emergency response inspector services. A RER-DERM Division or Section chief provides project coordination and designates a field supervisor who oversees collection of samples. RER-DERM also provides the vehicles, vessels, field meters, and expendable equipment and supplies to support the monitoring activities.



### 06.04.1 Sample Parameters

Surface water sampling and analysis parameters include fecal coliform, enterococcus, turbidity, salinity, temperature, and dissolved oxygen.

### 06.04.2 Schedule

Initial sampling focuses on the immediate vicinity of the discharge(s). The sampling area may be modified on subsequent days, taking into account site factors such as currents, water flow, tides, and wind-driven circulation patterns, with an emphasis on sites where public contact is likely. Sampling continues at the frequencies noted below until water quality is similar to typical conditions or meets water quality standards.

### 06.04.3 Initial “Day One” Sampling

If the discharge begins and is reported to RER-DERM prior to 2:00 pm, a Day One sampling protocol is implemented. Surface water samples are collected at suspected point(s) of discharge to surface waters. If the receiving water is a tidal water body or a canal tributary ultimately discharging to tidal waters, samples will be collected upstream and downstream of the suspected sources of discharge.

Exact numbers and locations of sample sites is determined after review of pertinent information, including the location and volume of the source, currents, water flow, tides and wind-driven circulation patterns, and sites where public contact is likely. Exact locations of sampling may be modified in the field due to access or other pertinent site conditions found by the sampling staff. Sampling will be conducted by RER-DERM using the following guidelines:

1. Collect one sample approximately 200 yards upstream of the discharge.
2. Collect downstream samples at any parks, beaches, street-ends, or locations providing public access within 1 mile of the discharge site, or 2 miles if the total volume of the release impacting surface waters is greater than 50,000 gallons.
3. Collect samples at approximately 0.5-mile intervals for a distance of 1 mile downstream of the discharge point (up to 2 miles if strong currents or winds exist that would cause rapid movement of the discharge plume) if there are no clear points of public access.

4. Assemble and maintain field kits in the Natural Resource Division containing an adequate number of sampling containers and related expendable materials to expedite sampling.

#### 06.04.4 “Day Two” Sampling

Day Two surface water samples are collected at all Day One stations. If the volume of discharge is estimated in excess of 1 million gallons, samples are collected in adjoining basins or at public access areas within a 5-mile radius of the discharge. If beaches are impacted, DOH samples the beaches. Locations are determined in the field, but may include sites routinely monitored or for which background information is available or other public areas. In addition, up to 10 elective samples are collected at the discretion of the field supervisor if a visible plume can be detected and taking into account tides, canal discharges, wind-driven circulation, or other factors that could influence movement of contaminated water.

#### 06.04.5 Continued Sampling

The Day Two sampling protocol, including elective stations, will continue every second day thereafter, at selected stations where public access is likely and at stations where violations of water quality standards were documented. This sampling will continue until water quality meets standards or returns to typical conditions.

### 06.05 Water Quality Analysis

Sampling methods follow RER-DERM's established quality assurance and quality control (QA/QC) procedures. Temperature, salinity, and dissolved oxygen are determined using field instrumentation. Bacteria, turbidity, BOD<sub>5</sub>, and total suspended solids samples are collected according to procedures in RER-DERM's approved *Field Comprehensive Quality Assurance Plan* (Field CQAP) and delivered to a laboratory holding NELAC Institute certification for analyses to be conducted.

#### 06.05.1 Quality Assurance

All sampling methods are in accordance with RER-DERM's Field CQAP for Biscayne Bay Surface Water Quality monitoring. This plan has been reviewed and approved by FDEP in

connection with the Biscayne Bay Surface Water Improvement and Management Program. All laboratories analyzing samples collected during the monitoring are required to have NELAC certification to perform analysis of the specific parameter(s), a current FDEP-approved QA plan for all analyses conducted. FDEP requirements are consistent with 40 CFR Part 136 procedures and protocols.

### 06.05.2 Field Parameters

Temperature, salinity, and dissolved oxygen are determined in the field using a Yellow Springs Instrument (YSI) multi-parameter water quality instrument (or equivalent) in accordance with procedures in the approved Field CQAP. RER-DERM's Natural Resources Division maintains a minimum of five multi-parameter water quality instruments in the event that multiple meters or a backup is required.

### 06.05.3 Laboratory Analyses

All samples are delivered to a laboratory holding NELAC certification for analyses to be conducted. Bacteriological samples are analyzed using the membrane filter (MF) method, or other EPA approved method. Bacteria, turbidity, BOD<sub>5</sub>, and total suspended solids samples may be delivered to a contract laboratory for analysis. All analyses are carried out according to the NELAC Institute's certifications and procedures in RER-DERM's approved Field CQAPs.

### 06.05.4 Laboratory Results and Reporting

RER-DERM receives verbal bacteria analyses results within 48 hours of delivering the samples to the laboratory. The results are emailed to EPA, FDEP, MDWASD, and the Miami-Dade Department of Health (DOH) within one hour of RER-DERM receipt to facilitate determination of public access restrictions and required notifications.

A final written report of bacteria analyses is provided by the contract laboratory to RER-DERM within 5 working days of the sampling event. Results of other laboratory results are provided to RER-DERM by the contract laboratory within 10 working days of the sampling event. RER-DERM compiles all reports and provides a written report, summarizing all data collected through

the duration of the event, to EPA, FDEP, and DOH within 15 working days after receiving the laboratory reports with results from the last day of sampling.

### 06.05.5 Field Sampling Results

Results of field sampling is tabulated with the results of the bacterial analyses in preliminary reports and forwarded to EPA, FDEP, and DOH by email. Field data is included in the final written summary report of the event.

## 06.06 Follow Up Measures

Upon completion of the emergency response and cleanup activities, the Operations Engineer is also responsible for ensuring the activities were properly documented in EAMS and for ensuring accurate field information was provided as part of the reporting and notifications activities.

### 06.06.1 SSO Volume Estimations

Due to the immediate need to determine whether or not the SSO reached the reporting threshold of 1,000 gallons, the Unit Supervisor is charged with developing a field estimate of the volume of sewage that was, or would be, discharged during the event. These calculations are performed when the emphasis is placed on controlling the spill, returning the system to normal operation, and mitigating the spill impacts and the initial SSO volume estimate or volume range should be considered just that – an initial estimate.

Upon completion of the emergency response activities, the Unit Supervisor responding to the spill is charged with developing the final volume estimate as well as an estimate of the volume recovered during the emergency response activities. The volume calculation methodology used depends on the type of spill event. The following types of volume calculations are used:

- **Volume Observation.** For spills that are contained, the volume discharged is based on the geometric area covered by the spill times the maximum depth of the spill to obtain a volume estimate in cubic feet that is then converted to gallons using 1 cubic foot = 7.48 gallons. The geometric areas tend to be circular (or portions of a circle) or rectangular. When needed, based on the spill shape, two or more geometric areas may be used to

estimate the spill area. Circular shapes use the Area = pi (or 3.14) times the radius squared formula ( $A = \pi r^2$ ) and rectangular shapes use the Area = length times width formula ( $A = l w$ ).

- Hole Releases. Volume estimates for releases from a force main under pressure are based on orifice formulas for flow rates that have been converted to a look up table. MDWASD has laminated a 3-page table that contains various sizes of “hole” columns versus various pressure rows. The orifice discharge table is included in Appendix G, Orifice Tables for SSO Discharge Volume Calculations. The volume rate of flow of the release is then obtained by following the appropriate hole size column down to the appropriate pressure row. The hole size is measured once the pipe section has been cut out and replaced with a new section of pipe. The pressure is obtained from SCADA historic records. Once the volume flow rate is read off the laminated tables, the flow rate is converted to a volume by multiplying the flow rate times the duration time for the spill. The duration time starts at the time the spill was reported and ends at the time the crew was able to stop the spill.
- Pump Station releases. Pump Station releases are usually calculated using the orifice and historic SCADA pressure records as described above. Pump Station releases are also calculated using manufacturers pump curves with the historic SCADA pressure readings to determine the pump flow rate in gpd and multiplied by the duration of the spill to estimate the total volume in gallons.
- Building Backup volumes. Building Backup volume is estimated by determining the square footage covered by the spill and multiplying by the spill depth. The resulting volume in cubic feet is converted to gallons using the 7.48 gallons/cubic foot conversion factor.
- Evidence Only SSOs. At times the FIC arrives at a site where the overflow has stopped, but there is evidence of a prior spill event. These instances are confirmed SSO events and are subject to the reporting requirements detailed previously in this SORP. However, it is impossible to calculate a volume when the crew has not observed the overflow. These SSO incidents are noted as having a “de minimis” volume in the EAMS field reports and in the subsequent reports to regulatory agencies.

Spills at WWTPs are reported under the NPDES permit requirements.

The SSO recovery volumes are typically calculated by counting the number of vacuum or tanker trucks used to collect the spill and transport to a downstream point within the WCTS or treatment plant. The volume is then estimated by multiplying the number of trucks times the capacity of each truck. If partial truck loads are involved, the supervisor estimates a percent full amount for the partial load and applies that percentage to the truck volume.

### 06.06.2 Cause Determination

In addition to the QA/QC check of the SSO volume estimate, the Unit Supervisor is responsible for validating the field assignment of SSO cause. Field reports from EAMS are reviewed and the crews are questioned in greater detail as to the field conditions. In most cases, the cause initially determined by the FIC is determined to be the actual cause; but in some cases, additional contributing causes or an underlying “root” cause is identified.

A refinement of the cause determination is usually not significant for SSO reporting and notification purposes, but is important when defining additional corrective actions to prevent future SSO events. SSO prevention is discussed in Section 08, SSO Prevention.

### 06.06.3 Follow Up Corrective Actions

The immediate emergency response activities are focused on completing sufficient corrective action to restore normal flow conditions. In most cases, MDWASD crews are able to resolve the cause of the problem during the emergency response. However, MDWASD also conducts follow-up “root cause” analyses to ensure that additional corrective actions that may be required to prevent recurrence are also completed. The root cause analyses are described in Section 08.2, Root Cause Analysis, and the types of follow up corrective actions are described in Section 08.3, Preventative Strategies.

## 07. SSO Response Preparedness

This section identifies the required staffing and resources and describes the preparedness training conducted by MDWASD to ensure effective implementation of the SORP.

### 07.01 Staffing and Resources

MDWASD staff and resources are required for effective implementation of the SORP, including staff to:

- Receive customer complaints and monitor SCADA alarms;
- Coordinate public notification and agency reporting;
- Respond to emergency events;
- Coordinate and plan emergency repairs;
- Complete follow up corrective actions;
- Conduct root cause analyses;
- Implement proactive O&M; and
- Implement preventative corrective actions.

Additionally, RER-DERM staff and resources are required to:

- Plan and conduct water quality sampling;
- Complete, or contract for completion, of water quality analysis;
- Advise on locations for the posting of warning signs for potential public health threats;
- Coordinate FOG source control activities, and
- Perform the planned new initiative for FOG-related educational activities.

Staff and resources required to implement the activities detailed in this SORP are provided by MDWASD and RER-DERM. Most of the staff with assigned SORP-related responsibilities are not assigned to the SORP for 100 percent of their time, but divert from other duties on an as-needed basis. During development of this initial SORP, it was determined that the CD-required

changes in the SORP, particularly the repeat SSO identifications and the need to have more detailed calculations for SSO volume estimations, mean that additional MDWASD staff will be required during the phased implementation of the SORP. The recommended additional staff requirements are summarized in Table 07.1.

**Table 07.1**  
**Recommended Staffing Additions for SORP-Related Activities**

Position	Personnel	Abbreviated Description
<b>Wastewater Collection and Transmission Line Division (WWCTLD)</b>		
Field Engineer	1 (1 car, 1 field use laptop with EAMS access)	Provide support to field supervisor and crews responding to SSO and Building Backup events by acquiring data and performing preliminary calculations for SSO volume estimations. Responsible for coordinating transmittal of field data to appropriate support departments and sections within both MDWASD and RER-DERM to meet local and regulatory reporting and notification requirements of the consent decree and EPA/FDEP regulations. Assist in Root Cause Analyses, including providing data from various EAMS investigations.
Office Engineer	1 (1 car, 1 field use laptop with EAMS access)	Provide office support to field supervisors, engineers, and crews responding to SSO and Building Backup events by performing research, finalizing preliminary calculations, and transmitting field and report data to appropriate support departments and sections within both MDWASD and RER-DERM to meet local and regulatory reporting and notification requirements for the consent decree and EPA/FDEP regulations. Assist in Root Cause Analyses, including such things as identifying Repeat SSOs.
<b>Pump Station Division (PSD) Position</b>		
Operations Engineer	1 (1 car, 1 field use laptop with EAMS access)	Evaluate flow diversion, flow transmission, and plant flow sharing options and alternatives to maximize operational efficiency and to minimize flow disruptions during emergency situations. Provide SSO response coordination between WWCTLD, PSD, and WWTMD to ensure proper emergency planning, logistics control, and preparedness training needs. Assist in coordinating preventative measures especially where such measures require action by multiple MDWASD divisions and departments. Coordinate identification of low manholes upstream of pump stations to facilitate WWCTLD coordination and to perform on-going estimates of “time to overflow” conditions for stations under average and peak inflow rates.
<b>Proposed Additional Staff</b>	<b>3</b>	

In addition to the SORP-related additional staffing resources listed in Table 07.1, other MDWASD divisions, including the WWTMD and the PSD, are pursuing efforts to increase staff



to provide full 24/7 coverage as part of other CMOM Program implementation activities. Full coverage is already provided in the Communications Center where customer complaints are received and SCADA alarms are monitored. Such additional shift coverage should further reduce the response times for emergency crew mobilization for those divisions.

## 07.02 Preparedness Training

MDWASD intends to implement a Preparedness Training Program for MDWASD employees and other affected Miami-Dade County agencies, including RER-DERM. The program is envisioned to include:

- Workshops conducted with managers and key personnel to review the established emergency response activities and current SORP procedures and protocols;
- Field reminders during routine monthly meetings as a refresher on emergency response procedures, safety, and public health/environmental protective measures (such as identification of Critical Wildlife Area boundaries for personnel working near Biscayne Bay and Virginia Key);
- Preparedness training sessions to provide new or reassigned personnel who may be involved in a discharge event with an overall understanding of the response actions; and
- Educational outreach activities to MDWASD contractors and external contractors to proactively address potential problems with Florida's Sunshine Ticket utility location program and prevent "contractor hit" incidents.

MDWASD's emergency response planning has been in place for approximately 20 years under the UDCP. Different levels of emergency response have been, and will continue to be, executed on a regular basis, as every wastewater spill event, whether more than 1,000 gallons or not and whether they discharge to receiving waters or not, share many common response elements. Thus, emergency responders are able to "practice" emergency response on a fairly regular basis.

These responses provide the opportunity to expose the need for any revisions or clarifications of responsibilities, and which are discussed during the monthly root cause analysis meetings. As

noted in the description of the root cause analysis meetings, one of the goals of the monthly meetings is to define “lessons learned” from the preceding month’s incidents.

Throughout the implementation of the SORP personnel training, field trials of emergency response procedures, and workshops with managers and key personnel will be conducted on an as-needed basis.

## 08. SSO Prevention

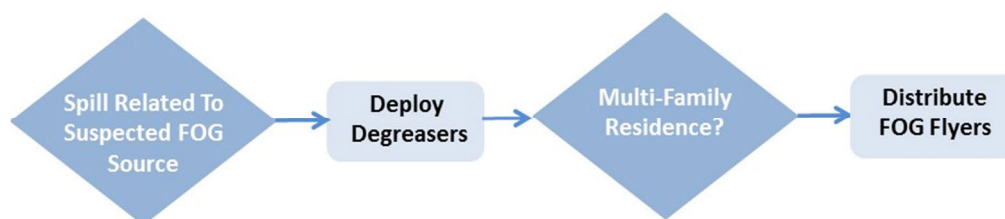
A number of SSO Prevention activities are actually implemented under other CMOM Programs; however, those prevention activities are briefly summarized in this SORP. Section 08.1 describes the predictive techniques used to identify problems for correction before an SSO occurs. Section 08.2 describes the root cause analyses performed to ensure follow up corrective actions to prevent recurrences are identified and tracked. Section 08.3 describes the preventative strategies employed to reduce or eliminate the potential for the various types of SSO events.

### 08.01 SSO Predictive Techniques

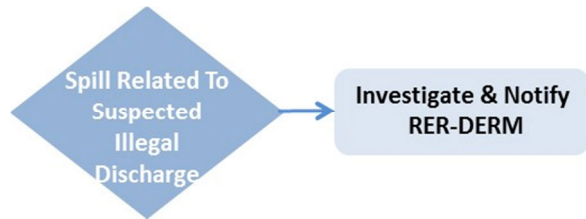
MDWASD employs an extensive remote monitoring network as a predictive technique to identify conditions that could lead to SSOs or Building Backups. SCADA monitors and alarms are installed at pump stations and treatment plants throughout the WCTS as detailed in the PSOPMP and the WWTP OMP. Additionally, MDWASD has approximately 15 remote level sensors that transmit high level alarms installed in manholes located in sensitive areas or at manholes where additional forewarning of surcharge conditions allows a longer response time before an actual overflow occurs. The existing sensors are being used in a pilot program to determine the effectiveness of the technology to meet MDWASD needs.

SSOs, especially dry weather SSOs, can occur at somewhat random locations throughout the WCTS. However, once an SSO occurs, that occurrence can be an indication of conditions within the WCTS where other SSOs may also occur. Consequently, MDWASD has implemented the following immediate protocols to undertake to prevent additional SSO occurrences. These protocols are illustrated in the flow charts in Figures 08.1 through 08.5.

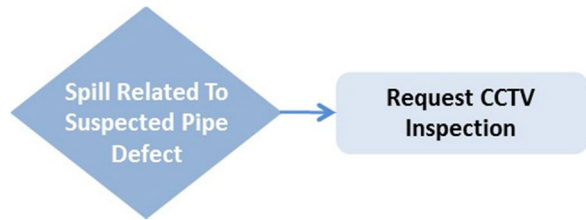
**Figure 08.1**  
**FOG-Related SSO Immediate Prevention**



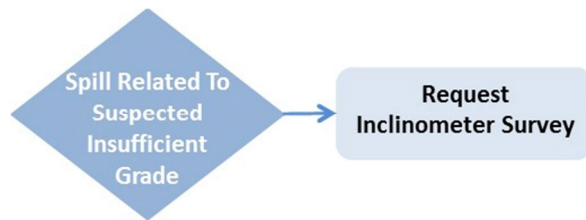
**Figure 08.2**  
**Illegal Discharge-Related SSO Immediate Prevention**



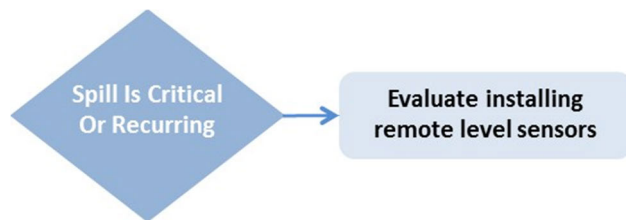
**Figure 08.3**  
**Pipe Defect-Related SSO Immediate Prevention**



**Figure 08.4**  
**Insufficient Grade-Related SSO Immediate Prevention**



**Figure 08.5**  
**Critical Location or Recurring SSO Immediate Prevention**



## 08.02 Root Cause Analysis

The WWCTLD conducts monthly reviews of SSO events that occurred during the previous month to identify “lessons learned” and define potential additional corrective actions. The goal of these monthly reviews is to:

- Define root cause of failures,

- Check historical data for patterns that may indicate potential failure conditions,
- Define potential improvements in the procedures and protocols to improve response or better control SSO discharges or Building Backups, and
- Define additional preventative actions to reduce the potential for recurrence.

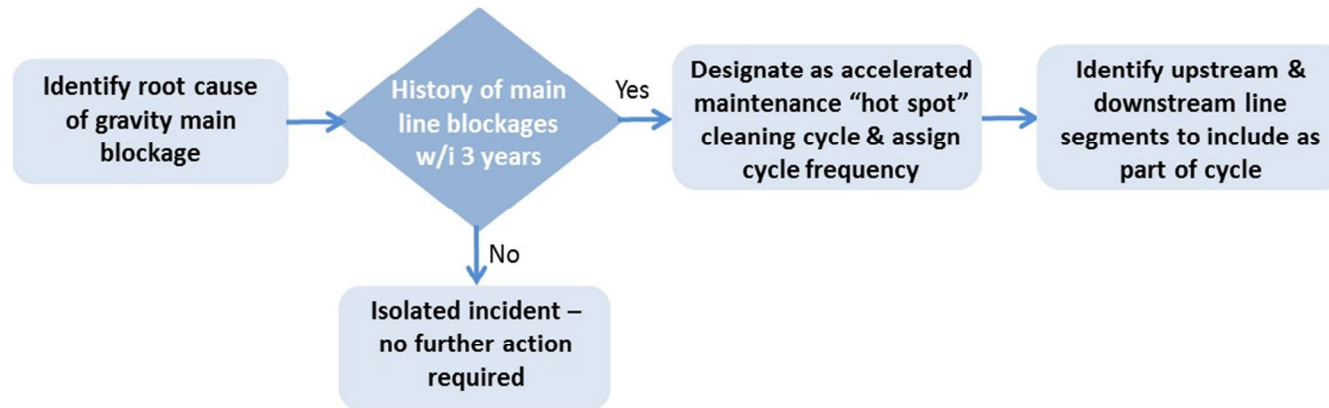
In preparation for the monthly SSO root cause analysis meetings, each WWCTLD Area Supervisor reviews the SSOs associated with gravity sewers or force mains that occurred during the previous month within his or her service area. A Spill Application module has been developed to track spill data for these meetings. This module is a ASP.NET Web application module that connects to the central Structured Query Language (SQL) Server Spill database to read spill date, present spill data to users, and update spill data based on users input. Additionally, EAMS queries for asset data are used to provide supporting asset information and allow each supervisor to easily review key SSO reports, work orders, and asset data associated with each SSO event. Repeat SSOs are identified as well as the date the last time that particular sewer was cleaned. Repeat SSO data for the previous 3 years is considered when deciding whether or not the sewer should be placed on a “hot spot” list for more frequent sewer cleaning. For force main-related SSOs, all historical records are considered.

The post event analyses further ensure that if a “temporary fix” has been applied, steps to make a proper, permanent fix are identified and implementation is initiated. The analyses also review the response efforts to ensure “lessons learned” during the response. Full implementation of the root cause analysis activities and associated repeat SSO identifications will require the additional staff as previously recommended in Table 07.1.

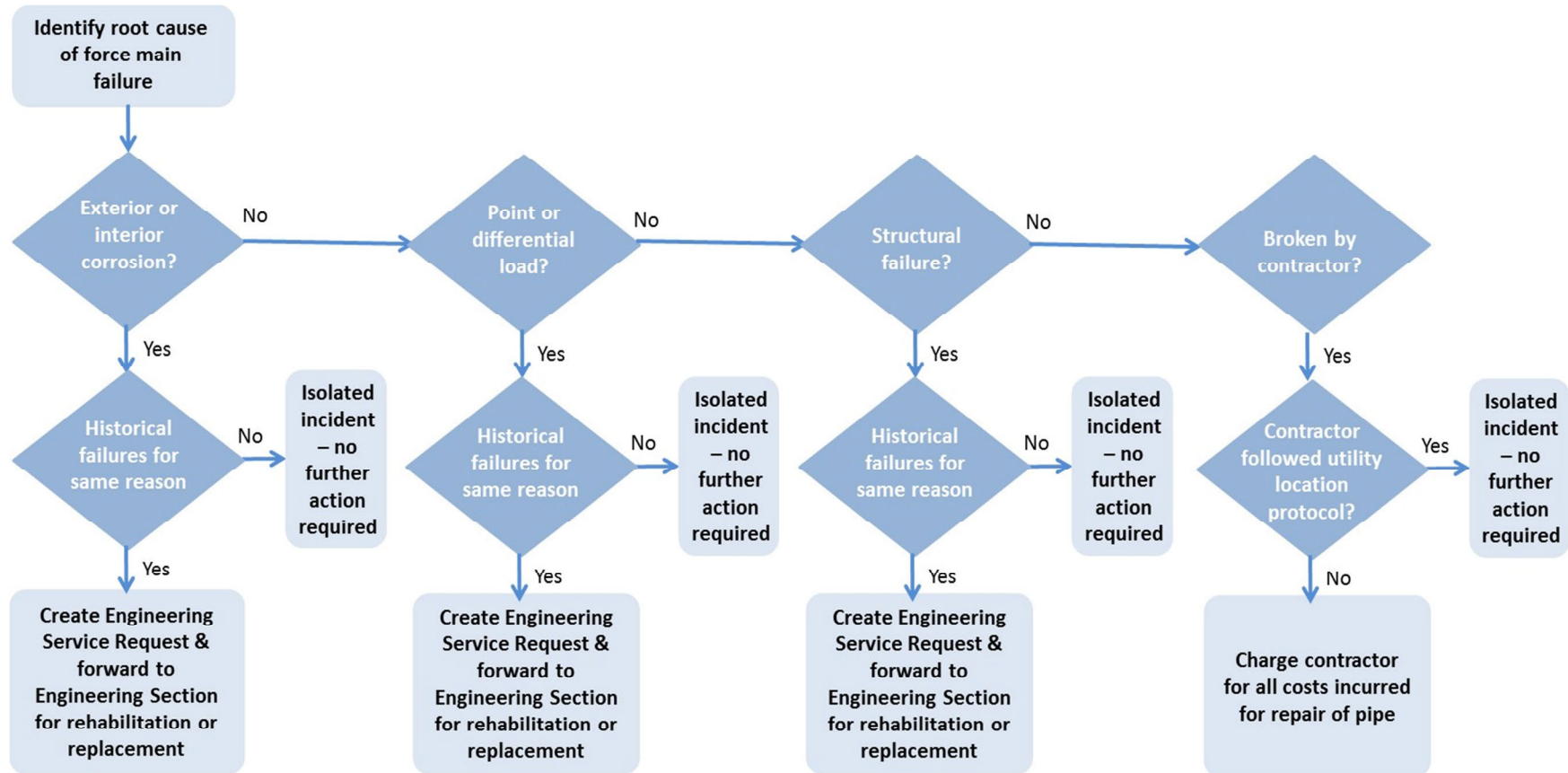
Due to the nature of pump station-related problems, the PSD Supervisors generally have to conduct root cause analysis as part of the process of determining the cause of the pump station problem. Thus, follow-up monthly SSO root cause analysis meetings are not necessary for the PSD.

The root cause analysis flow charts are illustrated in Figures 08.6, 08.7, and 08.8 for gravity mains, force mains, and ARVs, respectively.

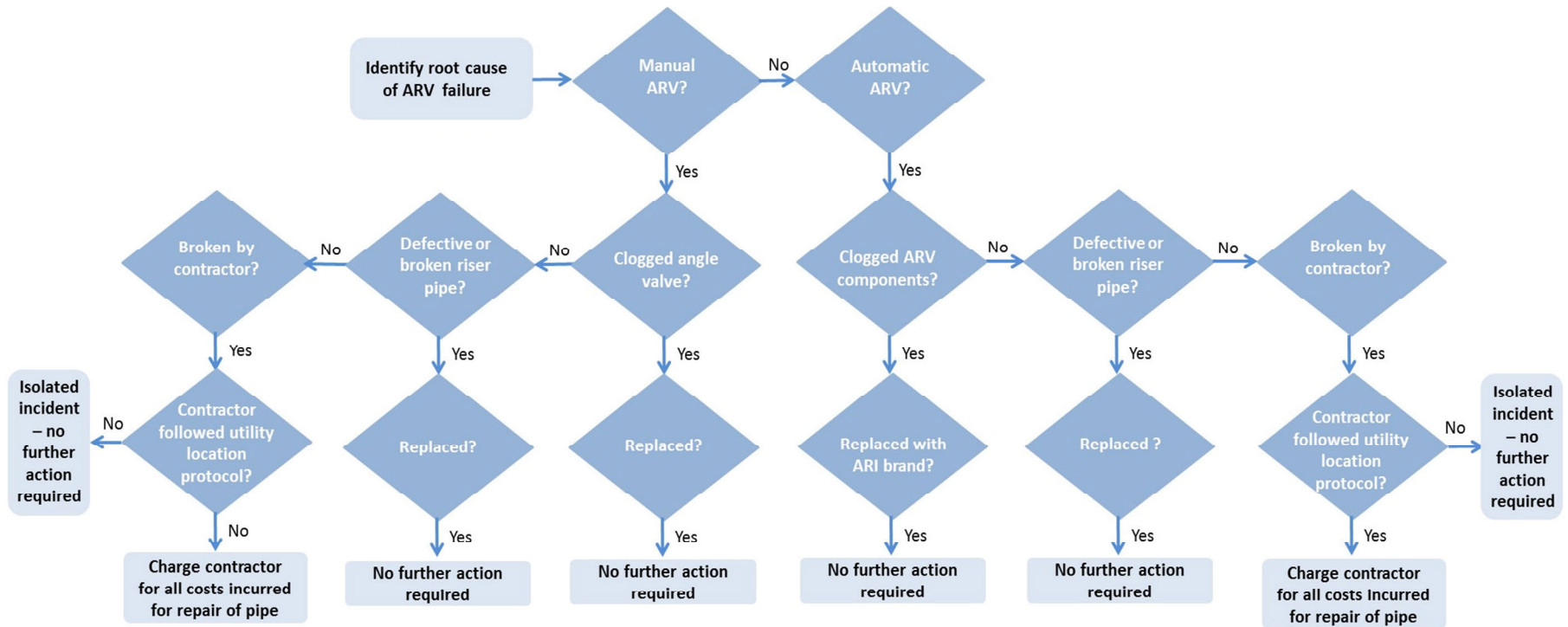
**Figure 08.6**  
**Gravity Main Root Cause Analysis Flow Chart**



**Figure 08.7**  
**Force Main Root Cause Analysis Flow Chart**



**Figure 08.8**  
**Air Relief Valve Root Cause Analysis Flow Chart**





## 08.03 Preventative Strategies

The following subsections detail MDWASD's plans to correct or repair problems causing SSOs and Building Backups. Plans have been developed for all of the major types of SSO causes.

### 08.03.1 FOG-Related SSO Prevention

As indicated in the MDWASD *2014 Annual Report* to EPA/FDEP, the largest number of SSO events were due to fats, oils, and grease (FOG) blockages in gravity sewer mains. As noted in the root cause analysis discussion above, the WWCTLD reviews the Spills Application module data and EAMS maintenance history for the sewers involved when a FOG-related SSO occurs. The sewers are added to "hot spot" lists designated for more frequent sewer cleaning to reduce the number of blockages and SSOs resulting from those blockages. The EAMS maintenance history for the assets involved in the analysis is reviewed for the life of the EAMS database; however, the decision to add particular gravity sewer segments to the hot spot list is based on the previous 3-year history.

In addition to the proactive sewer cleaning activities, MDWASD coordinates with RER-DERM and its FOG Control Program to implement source controls for customers such as food service establishments and industries that have the potential to discharge significant quantities of FOG into the public sewer system. Under the CD, the County was required to review, evaluate, and revise its Grease Trap Ordinance and FOG Control Program by June 6, 2015. As part of that submittal, RER-DERM developed a proposed Ordinance for EPA/FDEP approval.

The FOG cleaning and FOG source control activities targeted to commercial and industrial sources of FOG discharges that have been conducted to date have facilitated a reduction in FOG-related SSO events; however, it has also been recognized that individual customers can also discharge significant quantities of FOG into the public sewer system. These residential discharges can be a particular problem in high density areas or in neighborhoods with similar cooking practices. RER-DERM is implementing a number of FOG educational efforts targeted at such residential customers.

The RER-DERM website at <http://www.miamidade.gov/environment/fats-oils-grease.asp> contains the grease trap enforcement and the educational materials being used in the FOG control program.

### 08.03.2 Force Main Break-Related SSO Prevention

The second largest number of SSO events, but which accounted for the largest volume discharges, was associated with force main breaks. To minimize SSO discharge volume during such incidents, each major force main within the WCTS has a shutdown plan to reduce the amount of flow reaching the break. The shutdown plans are implemented as soon as a break or other leak is identified.

In recent years, force main breaks have been approximately equally divided between breaks caused when a contractor damages the pipe and breaks caused by structural problems. There are also usually a number of force main breaks caused by corrosion issues. Preventative measures for each of these types of force main-related SSO causes are described in the following paragraphs.

**Contractor-Involved Breaks.** The same preventative measures described herein are applicable both for contractor-involved force main breaks and for contractor-involved gravity sewers. The predominate preventative measure is to accurately locate the force main and gravity sewer pipes prior to contractors working in the area. Such accurate field location requires the assets to be accurately located within MDWASD's GIS database. Under the GIS Program improvements required by CD Paragraph 19(c)(x), new assets will be added to the GIS system within 90 calendar days of their activation in the field; damage investigators will "flag" GIS inaccuracies for correction as part of the existing AASIS process (with a higher priority included for any inaccuracy that resulted in an SSO event); and provision for additional GIS and refresher training (especially to facilitate wider usage of the AASIS process).

However, even with accurate asset field locations, contractors may consider "contractor hit" instances as a normal cost of doing business. To further ensure contractor compliance, MDWASD is increasing efforts both to assess damages for contractor-caused incidents. As part of the SORP implementation, additional contractor educational efforts will be undertaken to

ensure contractors are aware of requirements under Florida's Sunshine Ticket program and how best to communicate and coordinate with MDWASD staff responsible for utility locations and damage claims.

**Structural-Related Breaks.** Structural breaks are usually associated with point loads in sections with inadequate bedding. The historical record reviews for these issues are key to prevention. When a force main has a history of such breaks, the WWCTLD reviews the length of the force main and when the risk of additional breaks is high, recommends replacement of sections of the force main, or the entire force main, to ensure proper bedding on the new pipe to eliminate or reduce point loads being imposed.

**Corrosion-Related Breaks.** Corrosion-related force main breaks can be caused by both internal and external corrosive environments. Under CD Paragraph 19(g)(i)(A), MDWASD is evaluating potential sulfide and corrosion options. Hydrogen sulfide damage in a force main occurs in areas where air pockets develop (unprotected high points) and at hydraulic jumps (manholes/outfalls) in the areas of interface between pressurized force mains and gravity sewers. Current control measures for interior corrosion include requiring an interior lining on all ductile iron pipes and requiring installation of air release valves (ARVs) at all high points in the force main. Exterior corrosion can occur in corrosive soils or where the force mains are in close proximity with other pipes of dissimilar materials. Current control measures for exterior corrosion include requiring use of protective coatings (typically corrosion resistant wrap) on force mains under corrosive soil conditions. In areas where the soil contains high salinity, a non-ferrous pipe material such as high density polyethylene (HDPE) or thermoplastic pipe will be required upon completion of recommended revisions to current design standards.

The *Force Main Operations, Preventative Maintenance, and Assessment/Rehabilitation Program* (FMOPMARP) will detail criticality assessment and prioritization findings. The FMOPMARP will also address additional pH monitoring under the Industrial Pretreatment Program especially for bottling plants to determine the need to require pretreatment to ensure discharges comply with the required pH range. The subsequent criticality assessment and prioritization report will detail potential sulfide and corrosion control option evaluations.

### 08.03.3 Air Release Valve-Related SSO Prevention

As noted in Subsection 08.03.2, Force Main Break-Related SSO Prevention, MDWASD installs ARVs on force main high points to allow corrosive gases to escape and prevent interior corrosion in force mains. Most ARV failures are caused by clogged gaskets or clogged mechanisms inside the automatic ARVs.

To prevent ARV-related SSOs, all ARVs are monitored through MDWASD's operation, exercising, and cleaning program. Manual ARVs are inspected/cleaned/replaced every 6 months. Automatic ARVs are inspected/cleaned every month. Degreaser is applied during the inspection to reduce grease-related blockages. The ARV O&M program along with changes in ARV design and installation practices has resulted in significant reduction in ARV-related SSO events over the years. However, with the large number of ARV installations associated with over 1,000 force mains throughout the County, it is difficult to further reduce the number of SSOs. SSOs that do occur at an ARV are typically a very low volume leak.

### 08.03.4 Pump Station-Related SSO Prevention

MDWASD experiences a relatively low number of pump station-related SSOs in comparison to the large number (in excess of 1,000) pump stations within the WCTS. To further minimize the number of pump station-related SSOs, MDWASD's *Pump Station Operations and Preventative Maintenance Program* (PSOPMP) is implementing additional predictive maintenance activities, including vibration analysis, thermal imaging, insulation resistance, and oil analysis. To accomplish the additional predictive analysis activities, as well as to add shift coverage that will enable faster emergency response, the PSD's proposed staffing plan totals 170 additional personnel.

Under the GIS program improvements, efforts are underway to ensure manholes with the lowest rim elevations are identified upstream of pump stations. The identification of the low manhole upstream of each pump station, while potentially useful in being able to allow field crews to reach the overflow site more quickly and thus possibly divert further incoming flow until the backflow from the pump station goes back down, is unlikely to significantly reduce the already low number of SSOs caused by flows backing up from the pump stations.

### 08.03.5 Capacity-Related SSO Prevention

MDWASD has devoted considerable resources to preventing capacity-related SSOs. The programs detailed below have been largely successful in eliminating capacity-related SSO events when wet weather peak flows are less than the 2-year design storm that has historically been used to size the County's wastewater infrastructure. The program and activities used to address capacity issues are briefly summarized below.

***Adequate Pumping Transmission and Treatment Capacity (APTTC) Program.*** This program is devoted to proactively addressing the provision of adequate capacity within the WCTS. Hydraulic modeling is used to evaluate system capacity and the inter-relationships between the large number of pump stations and inter-connected force mains within the WCTS. Projected wastewater flows from large new development or redevelopment projects are routed through the hydraulic model to identify areas within the downstream WCTS that may need to be upgraded or flow re-routed to properly accommodate the flow increase.

***Pump Station Improvement Project (PSIP).*** The PSIP is devoted to evaluating pump stations within the WCTS that are beginning to exceed the 10-hour per day NAPOT operating time threshold, or the equivalent based on power usage. Pump Stations exceeding this criterion are evaluated and a Remedial Action Plan developed to bring the station back into compliance. No building permits are issued for connection to the WCTS upstream of that station until the potential capacity issue is resolved.

***Sewer System Evaluation Survey (SSES) and Infiltration/Inflow (I/I) Reduction Activities.*** The WWCTLD implements routine O&M programs to control I/I entering the WCTS to maximize the system capacity of existing assets. The WWCTLD routinely conducts closed circuit television (CCTV) inspection of about 1 million feet of gravity mains a year in conjunction with SSES activities to evaluate sewer condition and identify sources of potential I/I or structural issues. In addition to the SSES activities, the WWCTLD conducts sewer cleaning operations to proactively clear blockages and identify potential obstructions that reduce capacity that may be needed during wet weather events.

### 08.03.6 Building Backup Prevention

MDWASD's capacity-related SSO prevention activities are also applicable to reducing the potential for Public Building Backups that might be caused by inadequate sewer capacity during wet weather events.

Public Building Backups occurring due to blockages in the sewer main or breaks in the public lateral are prevented by maintaining free-flowing sewer conditions. These free-flowing sewer conditions are achieved through preventative actions such as routine or hot spot sewer cleaning and routine CCTV inspections. The hot spot cleaning locations are determined from the monthly root cause analysis meetings. The routine CCTV inspections are conducted as part of the SSES and I/I control activities described above.

Additionally, MDWASD is pursuing additional investigations into proactive measures that might be used during hydraulic cleaning operations to further reduce the potential for "splash" type events caused by private plumbing conditions.

## 09. Climate Change Impacts

In May 2014, the Miami-Dade County Board of County Commissioners passed a Resolution requiring that all County infrastructure projects “shall consider” the potential impacts of sea level rise and storm surge during all project phases (including planning, design, and construction) to ensure that these projects will function properly for fifty years or the design life of the project, whichever is greater. The County has also requested consideration of other climate change implications for County infrastructure projects.

This section addresses climate change impacts for the SORP.

### 09.01 SORP Vulnerabilities

The currently anticipated SORP-related impacts of climate change impacts relate to the need to respond to predicted increases in the number of instances and the magnitude each of the following events:

- Prolonged storms,
- More intense storms,
- Sea level rise,
- Storm surge,
- Wind,
- Flooding,
- Higher groundwater levels, and
- Saltwater intrusion.

As these anticipated climate change events adversely impact the various WCTS assets, MDWASD will need to ensure SORP resources, protocols, and procedures are capable of addressing these adverse impacts. The existing SORP protocols and procedures are designed to address a wide range of incidents from the smallest Building Backup to a wide-spread, extreme hurricane event. However, the existing SORP resources are likely to be taxed to

address more frequent, more intense, and more prolonged adverse events that are expected to occur.

If, or when, such events begin to occur, MDWASD will need to evaluate committing additional staff and equipment to maintain the current level of service. Monitoring the performance measures defined herein will provide early indications of when changing climate conditions are beginning to overwhelm existing resources. Anticipated early performance measure indicators will be:

- Response times may rise,
- The times required to control SSOs and Building Backups may lengthen,
- The number of SSO or Building Backup incidents may increase, and
- The volume of SSO or Building Backup discharges may increase.

## 09.02 Climate Change Predictions

As a signatory to the South Florida Regional Climate Change Compact (SFRCCC), Miami-Dade joined other south Florida counties to develop a coordinated strategy for dealing with impacts of climate change. This includes a unified planning estimate for sea level rise projections. In October 2012, the SFRCCC released the report, *Regional Climate Action Plan*, which contained planning time horizons and potential changes to sea level. This report predicted up to 3 feet of sea level rise by 2075. This report built on the SFRCCC recommendations previously related in the 2011 report, *A Unified Sea Level Rise Project for Southeast Florida*, where recommendations from the U.S. Army Corps of Engineers (USACE) were reviewed for projections to 2030 and 2060.

The impact of climate change on the WCTS will vary depending on the geographic location within the service area. In general, WCTS assets will be exposed to three broad categories of climate manifestations and their associated components. First is the storm tide made up of the tidal cycle and the storm surge. Second is the role of hurricanes in South Florida was examined with the associated precipitation and winds. Third is the sea level rise and the associated impact on percolation and drainage, groundwater levels, and localized flooding.



Table 09.1 presents the Saffir-Simpson Hurricane Wind Scale showing the types of damage and the anticipated power impacts associated with various hurricane categories.

**Table 09.1**  
**Saffir-Simpson Hurricane Wind Scale**

Category	Sustained Winds	Types of Damage Due to Hurricane Winds	Anticipated Power Impacts
1	74 to 95 mph	Very dangerous winds will produce some damage	Extensive damage to power lines and poles likely will result in power outages that could last a few to several days.
2	96 to 110 mph	Extremely dangerous winds will cause extensive damage	Near-total power loss is expected with outages that could last from several days to weeks.
3 (major)	111 to 129 mph	Devastating damage will occur	Electricity and water will be unavailable for several days to weeks after the storm passes.
4 (major)	130 to 156 mph	Catastrophic damage will occur	Power outages will last weeks to possibly months. Most of the area will be uninhabitable for weeks or months.
5 (major)	157 mph or higher	Catastrophic damage will occur	Power outages will last for weeks to possibly months. Most of the area will be uninhabitable for weeks or months.

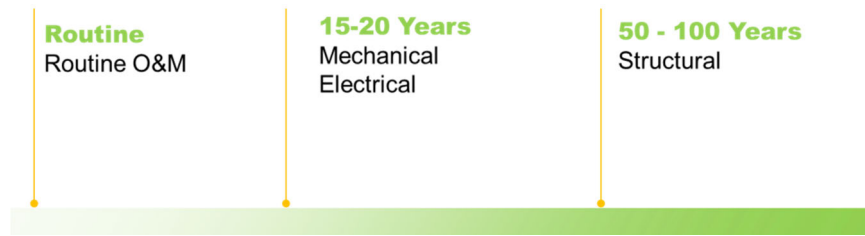
Source: <http://www.nhc.noaa.gov/aboutsshws.php>.

The framework for developing a WCTS asset plans focus primarily on two factors:

- Asset life versus planning horizon and
- Pertinent industry design guidance documents.

**Asset Life Versus Planning Horizon.** Asset improvements or new assets at the WCTS assets can be broadly categorized into three components: structural, electrical, and mechanical. As shown in Figure 09.1, each has a different service life that ought to be considered when making decisions for resiliency adaptations. Routine O&M also present an opportunity to introduce additional adaptations.

**Figure 09.1**  
**WWTP and Pump Station Generic Service Life Schematic**



The recommendation is that the climate resiliency feature be incorporated into WCTS asset upgrade and replacement design processes based on asset life. Specifically, the adaptation solution ought to coincide with the climate planning horizon that aligns with the asset life. For example, if the upgrade includes mechanical assets with a service life of 15 years, the corresponding time adaption feature would be determined during the basis of design report (BODR) process. Thus, the guidance takes the service life and the planning horizon as the framework; the specific action is to be determined during the BODR process when the project design is considered in totality. Table 09.2 outlines the guidance for planning horizons based on asset categories.

**Table 09.2**  
**Recommended Planning Horizon Based On Asset Life**

Asset	Asset Life	Asset Replacement	Asset Rehabilitation
Structural	50 to 100 years	Target 2075	Comprehensive Structural Assessment in Basis of Design Report
Mechanical	15 years	2030	2030
Electrical and Controls	15 years	2030	2030

**Pertinent Industry Design Guidance Documents.** A pertinent guidance document is the American Society for Civil Engineers Standard (ASCE 24-05) Flood Resistant Design and Construction, which issues guidance for types of structures and lowest floor elevations. ASCE recommendations already incorporate storm surge estimates into their flood calculations. For the Category IV structures, which include public utilities, ASCE recommends that the Design Flood Elevation (DFE) is the 2 feet over the Base Flood Elevation (BFE).

## 10. Appendices

*Appendix A: Example Domestic Wastewater Discharge/Abnormal Event Notification*

*Appendix B: Example Building Backup Event Notification*

*Appendix C: Verbal and Electronic Notification Flow Chart*

*Appendix D: Repeat SSO List for Period Ending March 30, 2015*

*Appendix E: Pump Station Upstream Low Manhole List*

*Appendix F: Sewage Backup Prevention Fact Sheet*

*Appendix G: Orifice Tables for SSO Discharge Volume Calculations*

THIS PAGE LEFT INTENTIONALLY BLANK

# APPENDIX A

## Example Domestic Wastewater Discharge / Abnormal Event Notification

THIS PAGE LEFT INTENTIONALLY BLANK



# DOMESTIC WASTEWATER DISCHARGE/ABNORMAL EVENT NOTIFICATION



MIAMI-DADE COUNTY WATER AND SEWER DEPARTMENT EMERGENCY COMMUNICATIONS SECTION

WASD Incident #: 345032 Version: 5 Version Type: Supplementary **Qualified UDP?** Yes  
 Incident Version Created On: 06/09/15 11:13 AM Job Order #: 1002870807  
 Location of Discharge: 8390 NW 25 ST DORAL 33122  
 Additional Location Description: CONSTRUCTION SITE  
 Reported by WASD Employee? Yes **Employee ID:** 00025216 **Employee Title:** Engineer 3  
**Reported by:** Vincent Flick  
 Utility Name: Miami-Dade Water & Sewer Phone Number: (305) 274-9272  
 Path of Flow: East On: NW 25TH ST

Occurred at/in: Force Main  
 Contractor Involved? Yes (Private Contractor) Private Contractor Name: SOUTHERN ENGINEERING  
 Discharge Due to/Caused by: Force Main Broken Other Cause  
 Additional Discharge Cause: BROKEN BY CONTRACTOR  
 Pipe Material: DIP (Ductile Iron Pipe) Pipe Size in inches: 20  
 Type of Water Discharge: RAW SEWAGE  
 Did Discharge Go to Public Access Area? Yes Did Discharge Go into Storm Sewer? Yes  
 Number of Storm Drain(s) Impacted: 1 Distance in Feet to Storm Drain(s): 10 Direction: West  
**Did Discharge Go into Surface Water?** Yes Distance in Feet into Surface Water:  
**Body of Water Name:** North Line Canal **Type of Water:** Canal  
 Weather Conditions: Clear Estimated Quantity of Sewage Released in Gallons: 75,000  
 Estimated Time Release Started: 06/04/15 10:45 PM Estimated Time Action Taken at Site: 06/04/15 11:33 PM

### ACTION TAKEN

Active Spill Observed? Yes Discharge Flow Stopped? Yes Discharge Stopped On: 06/05/15 01:00 AM  
 Spill Contained? Yes Area Cleaned? Yes Area Disinfected? Yes Method of Disinfection: Lime/Vactor  
 Spill Recovered? No  
 Public Notified? Yes Method of Public Notification: Post Signs Public Notified On: 06/04/15 11:33 PM

### AGENCIES NOTIFIED

AGENCY	NOTIFICATION POINT	METHOD	NOTIFIED TO	NOTIFIED ON
DEP	FDEP State Warning Point	Phone	Melissa	06/09/15 11:23 AM
RER	RER Compliance Desk	Phone	Nelson Martinez	06/09/15 11:23 AM
WASD	WASD Bertha Goldenberg	Phone	Left Message - Bertha	06/09/15 11:23 AM
DEM	DEM Notification Group	E-mail		06/09/15 11:23 AM
DEP	DEP Notification Group	E-mail		06/09/15 11:23 AM
DOH	DOH Notification Group	E-mail		06/09/15 11:23 AM
EPA	EPA Notification Group	E-mail		06/09/15 11:23 AM
HSG	Hazardous Subcommittee Group	E-mail		06/09/15 11:23 AM
RER	RER Notification Group	E-mail		06/09/15 11:23 AM
SFWM	SFWM Notification Group	E-mail		06/09/15 11:23 AM
WASD	WASD Interdepartmental Personnel	E-mail		06/09/15 11:23 AM

Future Contact Person: Marcelo Garcia Future Contact Person's Phone Number: (786) 552-8342  
**Form Completed by:** jdiaz WASD Of: Water & Sewer Department

### DEP USE ONLY

WRITTEN REPORT REQUESTED:    No/    Yes DUE DATE: \_\_\_\_\_  
 NAME: \_\_\_\_\_ TITLE: \_\_\_\_\_ SIGNATURE: \_\_\_\_\_ DATE: \_\_\_\_\_

THIS PAGE LEFT INTENTIONALLY BLANK



# APPENDIX B

## Example Building Backup Event Notification

THIS PAGE LEFT INTENTIONALLY BLANK

**Domestic Wastewater  
Building Backup Event Notification**

**Draft  
June 30, 2015**

WASD Incident #:	enter #		
Version:	enter #	Version Type:	enter #
Incident Version Created On:	enter date & time	Work Order #:	enter #

**CUSTOMER GENERAL QUESTIONS**

Name of Customer Initiating Report	enter name		
Customer Callback Number	enter #		
Property Address	enter address		
Does Customer Own Or Rent the Property?	yes or no	If renting, has owner been contacted?	yes or no
Building Type:	***See item #1 pull down		
Building Backup Type:	***See item #2 pull down		
Approximate date and time when the backup occurred:	enter date & time		
Date and time when customer call was received:	enter date & time	Visual status at the time of the call (by customer)	***See item #3 pull down
Has customer contacted a plumber prior to calling WASD?	yes or no	Did plumber's assessment point to WASD problem?	yes or no
Is there a record of a previous incident(s) of Building Backup(s)?	yes or no, yes - date		
Does the property have a cleanout near the property line?	yes, no, or unknown		
Does the property have more than one bathroom?	yes or no	Are both bathrooms experiencing the same problem?	yes or no
Is there evidence that sewage spilled outside the building?	yes or no		

**CUSTOMER ACKNOWLEDGEMENT QUESTIONS**

Was customer informed about WASD limits of responsibility?	yes or no		
Was customer informed about the billing process?	yes or no		
Was customer advised of WASD service fees?	yes or no		
Did the customer accept all fees and terms?	yes or no	Date and Time Stamp:	enter date & time

**ONSITE ASSESSMENT**

WASD employee dispatched	yes or no	Employee ID:	enter #
Estimated date and time of WASD arrival on-site	enter date & time		
Name of customer present on-site	enter name		
Visual status upon arrival on-site, remarks (by WASD)	enter WASD's description of the visual status		
Description of existing piping	enter WASD's description of the existing piping		
Cause assessment	***See item #4 pull down	Contractor involved in break?	yes or no

**FURTHER ACTIONS TAKEN**

Name of ISD-RM claims administrator notified	enter name	Phone Number:	enter #
Will cleaning be performed by WASD, outside contractor, or customer	***See item #5 pull down	Name of cleaning contractor dispatched	***See item #6
Approximate area cleaned	***See item #7 pull down	Approximate sewage backup volume	***See item #8 pull down
Date and time when cleanup was completed	enter date and time	Did the customer sign-off on the cleanup work?	yes, no, or NA

Clarifications for Pull Down Menu Items

\*\*\*Item #1: Single-family residential / Multi-family residential / Commercial / Industrial

\*\*\*Item #2: Toilet splash / Minor overflow from toilet / Tub or shower contained overflow / Major overflow flooded room / Major overflow flooded multiple rooms

\*\*\*Item #3: Enter the customer's description of the visual status

\*\*\*Item #4: Sewer main cleaning / Sewer blockage / Public lateral blockage / Private lateral blockage / Sewer main break / Public lateral break / Private lateral break / Sewer main capacity surcharge

\*\*\*Item #5: WASD / Outside contractor / Customer

\*\*\*Item #6: Steam Master / Outside contractor name / Customer name

\*\*\*Item #7: Enter the approximate area that was cleaned (obtained from cleaning crew or contractor) / NA (if customer responsible for cleaning)

\*\*\*Item #8: Enter the approximate sewage volume that was recovered (obtained from cleaning crew or contractor) / NA (if WASD is not responsible for cleaning)

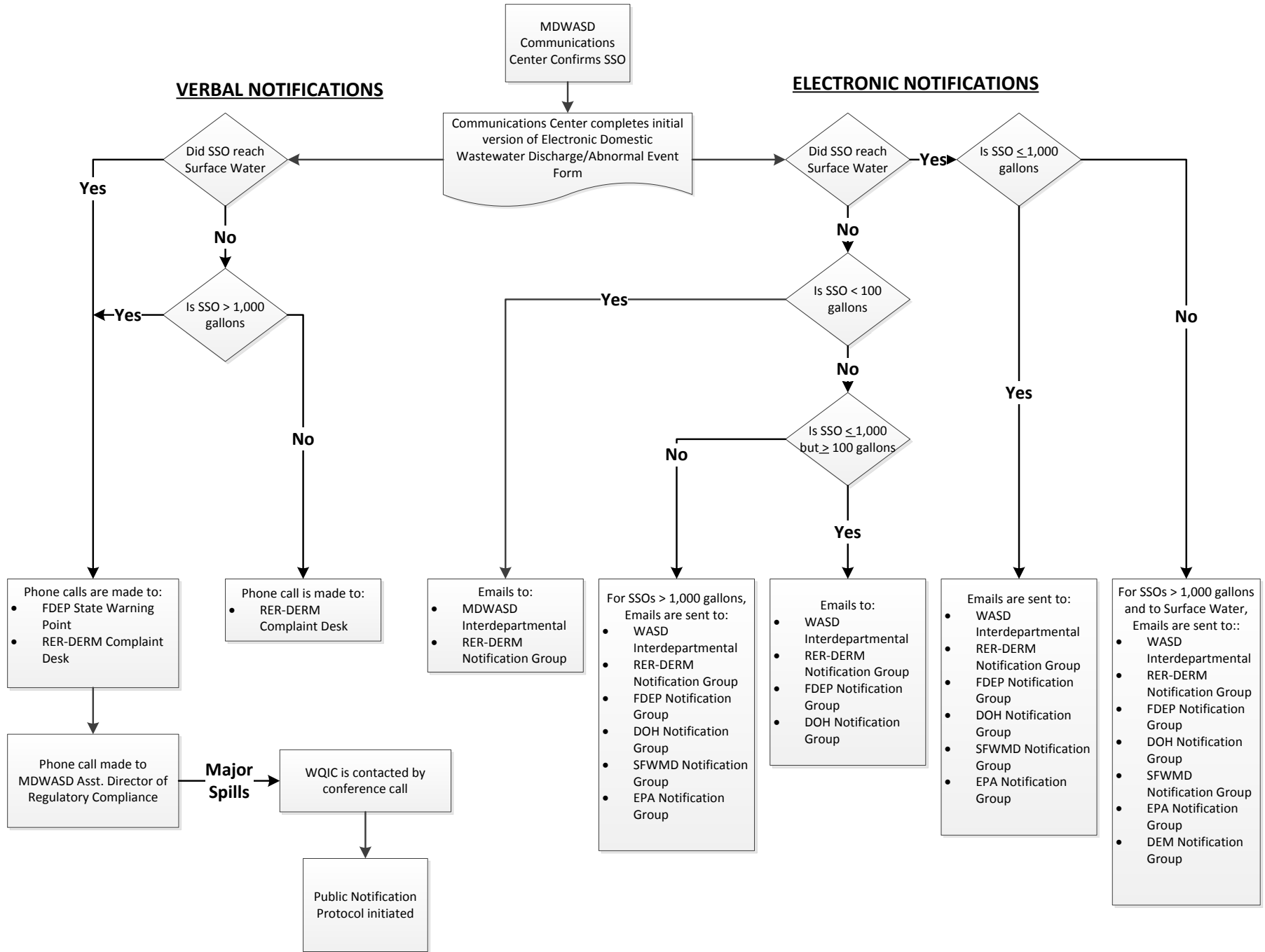
THIS PAGE LEFT INTENTIONALLY BLANK

# APPENDIX C

## Verbal and Electronic Notification Flow Chart

THIS PAGE LEFT INTENTIONALLY BLANK

# SSO Notification Flow Chart



THIS PAGE LEFT INTENTIONALLY BLANK



# APPENDIX D

Repeat SSO List for Period Ending  
March 30, 2015

THIS PAGE LEFT INTENTIONALLY BLANK

**List of Repeat SSOs - Last 12 months extending up to June 18, 2015 (does not include building backups)**

Date	Time	Location	Source	Release Started On	Discharge Stopped On	Estimate Duration in dd:hh:mm	Estimate Volume in Gallons
10-Apr-15	9:53AM	11161 SW 88 ST UNINCORPORATED MIAMI-DADE 33176	Gravity Main	04/10/15 09:53 AM	04/10/15 01:30 PM	0:03:37	25
12-Apr-15	5:05PM	11161 SW 88 ST UNINCORPORATED MIAMI-DADE 33176	Gravity Main	04/12/15 05:05 PM	04/12/15 06:45 PM	0:01:40	300
13-Jan-15	3:00AM	2575 NE 156 ST NORTH MIAMI 33160	North District WWTP	01/13/15 03:00 AM	01/13/15 03:35 AM	0:00:35	800,000
28-Feb-15	3:30PM	2575 NE 156 ST NORTH MIAMI 33160	North District WWTP	02/28/15 03:30 PM	02/28/15 09:00 PM	0:05:30	3,500,000
16-Sep-14	12:26PM	5825 NW 74 AVE UNINCORPORATED MIAMI-DADE 33166	Force Main	09/16/14 12:26 PM	09/16/14 04:17 PM	0:03:51	2,310
6-Apr-15	11:00AM	5825 NW 74 AVE UNINCORPORATED MIAMI-DADE 33166	System Valve	04/06/15 11:00 AM	04/06/15 12:55 PM	0:01:55	100
15-Jan-15	8:26AM	5901 NW 74 AVE UNINCORPORATED MIAMI-DADE 33166	Force Main	01/15/15 08:26 AM	01/15/15 11:35 AM	0:03:09	1,665
16-Jan-15	8:00AM	5901 NW 74 AVE UNINCORPORATED MIAMI-DADE 33166	Force Main	01/16/15 08:00 AM	01/16/15 11:00 AM	0:03:00	1,350
22-Jan-15	8:00AM	5901 NW 74 AVE UNINCORPORATED MIAMI-DADE 33166	Force Main	01/22/15 08:00 AM	01/22/15 09:30 AM	0:01:30	990
9-Mar-15	2:50PM	890 SW 84 AVE UNINCORPORATED MIAMI-DADE 33144	Gravity Main	03/09/15 02:50 PM	03/09/15 03:50 PM	0:01:00	25
16-Jun-15	4:00PM	890 SW 84 AVE UNINCORPORATED MIAMI-DADE 33144	Gravity Main	06/16/15 04:00 PM	06/16/15 05:00 PM	0:01:00	10
22-Aug-14	12:20PM	NW 84TH AVE & PARK BLVD UNINCORPORATED MIAMI-DADE 33126	Automatic Air Release Valve	08/22/14 12:20 PM	08/22/14 12:21 PM	0:00:01	1
5-Nov-14	2:30PM	NW 84TH AVE & PARK BLVD UNINCORPORATED MIAMI-DADE 33126	Automatic Air Release Valve	11/05/14 02:30 PM	11/05/14 03:15 PM	0:00:45	2

**List of Repeat Building Backups - Last 12 months extending up to March 31, 2015**

Date	Time	Location	Source	Release Started On	Discharge Stopped On	Estimate Duration in dd:hh:mm	Estimate Volume in Gallons
N/A	N/A	N/A	N/A	N/A	N/A	N/A	N/A

No repeat building backups were observed during the reporting period

THIS PAGE LEFT INTENTIONALLY BLANK

# APPENDIX E

## Pump Station Upstream Low Manhole List

THIS PAGE LEFT INTENTIONALLY BLANK

Low Manhole Per Pump Station Basin	
Pump Station #	Low Manhole #
0005	6
0006	19
0007	385
0008	19
0009	32
0010	14
0011	54
0012	
0013	
0014	86
0016	285
0017	11
0018	237
0019	29
0020	10
0021	54
0022	46
0023	31
0026	59
0027	60
0028	61
0029	3
0032	67
0033	15
0034	14
0035	2
0037	16
0038	62
0041	16
0042	62
0044	3
0045	4
0046	
0047	14
0048	287
0049	36
0050	47

Low Manhole Per Pump Station Basin	
Pump Station #	Low Manhole #
0051	14
0052	52
0053	9
0054	33
0055	4
0056	19
0057	15
0058	7
0059	46
0060	1
0061	15
0062	15
0063	7
0064	11
0065	30
0066	1
0067	32
0068	13
0069	9
0070	3
0071	38
0072	456
0073	29
0074	19
0075	2
0076	18
0077	2
0078	5
0079	55
0080	24
0081	18
0082	8
0083	31
0084	64
0085	35
0086	81
0087	81

Low Manhole Per Pump Station Basin	
Pump Station #	Low Manhole #
0088	2
0089	1
0090	27
0091	31
0092	3
0093	10
0094	120
0095	13
0096	5
0097	42
0098	14
0099	
0100	8
0101	37
0102	1
0103	46
0104	83
0105	6
0106	4
0107	40
0108	2
0109	50
0110	57
0111	5
0112	31
0113	1
0114	221
0115	46
0116	4
0117	156
0118	13
0119	2
0120	55
0121	125
0122	1
0123	37
0124	20

Low Manhole Per Pump Station Basin	
Pump Station #	Low Manhole #
0125	2
0126	8
0127	n/a
0128	8
0129	9
0130	70
0131	
0132	n/a
0133	4
0134	1
0135	18
0136	18
0137	2
0138	31
0139	2
0140	27
0142	72
0143	8
0144	97
0145	46
0146	9
0147	153
0148	32
0149	20
0150	64
0151	6
0152	77
0153	61
0154	17
0155	7
0156	6
0157	72
0158	6
0159	10
0160	75
0161	11
0162	54

Low Manhole Per Pump Station Basin	
Pump Station #	Low Manhole #
0163	17
0164	19
0165	0
0166	15
0167	6
0168	9
0169	46
0170	70
0171	193
0172	30
0173	48
0174	32
0175	155
0176	40
0177	23
0179	10
0180	13
0181	2
0182	n/a
0183	32
0184	125
0185	90
0186	457
0188	111
0189	4
0190	71
0191	3
0192	19
0193	1
0194	17
0195	13
0196	10
0197	38
0198	9
0199	14
0200	82
0201	3

Low Manhole Per Pump Station Basin	
Pump Station #	Low Manhole #
0202	4
0203	17
0204	17
0206	9
0207	22
0208	0
0209	26
0210	20
0211	9
0212	7
0213	10
0214	41
0215	4
0216	11
0217	123
0218	3
0219	2
0220	22
0221	29
0222	51
0223	
0224	3
0225	24
0226	4
0227	49
0229	9
0230	96
0231	n/a
0232	50
0234	125
0235	22
0236	98
0237	2
0238	22
0239	
0240	n/a
0241	n/a



Low Manhole Per Pump Station Basin	
Pump Station #	Low Manhole #
0242	n/a
0243	n/a
0244	n/a
0247	
0304	n/a
0305	78
0306	
0307	
0308	19
0309	5
0310	16
0311	14
0312	4
0313	4
0314	11
0315	3
0316	6
0317	19
0318	60
0319	13
0320	010A
0321	13
0322	15
0323	1
0324	2
0325	11
0326	62
0327	1
0328	1
0329	28
0330	51
0331	78
0332	104
0333	69
0334	36
0335	80
0336	11

Low Manhole Per Pump Station Basin	
Pump Station #	Low Manhole #
0337	63
0338	36
0339	4
0340	2
0341	16
0342	9
0343	5
0344	5
0346	
0347	
0348	
0349	10
0350	3
0351	54
0352	112
0353	4
0354	86
0355	43
0356	80
0357	17
0358	13
0359	60
0360	14
0361	18
0362	42
0363	20
0364	4
0365	9
0366	64
0367	99
0368	53
0369	16
0370	7
0371	16
0372	33
0373	44
0374	47

Low Manhole Per Pump Station Basin	
Pump Station #	Low Manhole #
0375	30
0376	8
0377	1
0378	001B
0379	8
0380	35
0381	24
0382	28
0383	30
0384	14
0385	15
0386	17
0387	9
0388	n/a
0389	20
0390	106
0391	24
0392	9
0393	5
0394	10
0395	10
0397	4
0398	11
0399	11
0400	4
0401	9
0402	4
0403	2
0404	74
0405	1
0406	11
0407	25
0408	5.0
0409	14
0410	16
0411	10
0412	8

Low Manhole Per Pump Station Basin	
Pump Station #	Low Manhole #
0413	8
0414	n/a
0415	453
0417	191
0418	
0419	65
0420	53
0421	
0423	23
0424	2
0427	6
0428	146
0429	146
0430	108
0431	3
0432	2
0433	25
0434	161
0435	16
0436	65
0437	71
0438	8
0439	4
0440	53
0441	65
0442	24
0443	5
0444	1
0445	7
0446	9
0447	3
0448	57
0449	
0450	59
0451	
0454	12
0455	50

Low Manhole Per Pump Station Basin	
Pump Station #	Low Manhole #
0456	3
0457	15
0458	n/a
0460	3
0461	17
0462	4
0463	77
0464	61
0465	4
0466	5
0467	54
0468	30
0469	n/a
0470	3
0471	26
0472	10
0473	10
0474	12
0475	4
0476	8
0477	41
0478	26
0479	49
0480	9
0481	71
0482	9
0483	6
0484	31
0485	56
0486	78
0487	45
0488	n/a
0489	82
0490	15
0491	10
0492	17
0493	18

Low Manhole Per Pump Station Basin	
Pump Station #	Low Manhole #
0494	19
0495	20
0496	21
0497	22
0498	23
0499	24
0500	63
0501	26
0502	55
0503	82
0504	188
0505	7
0506	29
0507	16
0508	2
0509	1
0510	80
0511	52
0512	5
0513	21
0514	2
0515	27
0516	
0517	23
0518	8.22
0519	42
0520	43
0521	20
0523	111
0524	17
0525	116
0526	7
0527	97
0528	5
0529	n/a
0530	100
0531	4

Low Manhole Per Pump Station Basin	
Pump Station #	Low Manhole #
0532	64
0533	97
0534	17
0535	29
0537	24
0538	96
0539	23
0540	29
0541	78
0542	7
0543	38
0544	45
0545	188
0546	9
0547	6
0548	3
0549	16
0550	11
0551	52
0552	44
0553	114
0554	44
0555	51
0556	14
0560	69
0561	35
0562	55
0563	113
0564	37
0565	15
0566	86
0567	6
0568	23
0569	190
0570	No data
0571	270
0572	7

Low Manhole Per Pump Station Basin	
Pump Station #	Low Manhole #
0573	4
0574	10
0575	70
0576	16
0577	1
0578	11
0579	8
0580	13
0581	4
0582	0
0583	4
0584	8
0585	2
0586	22
0587	4
0588	8
0589	69
0590	46
0591	23
0592	105
0593	3
0594	18
0595	18
0596	27
0597	12
0598	23
0599	11
0600	36
0601	89
0602	116
0603	8
0604	26
0607	21
0608	13
0609	10
0610	99
0611	25

Low Manhole Per Pump Station Basin	
Pump Station #	Low Manhole #
0612	7
0613	20
0614	10
0615	52
0616	26
0617	15
0618	6
0619	75
0620	16
0621	34
0622	3
0623	27
0624	9
0625	92
0626	1
0627	7
0628	90
0629	6
0630	22
0631	22
0632	17
0633	2
0634	2
0635	8
0636	45
0637	59
0638	45
0639	32-C
0640	53
0641	31
0642	23
0643	1
0644	
0645	13
0646	42
0647	67
0648	30-A

Low Manhole Per Pump Station Basin	
Pump Station #	Low Manhole #
0649	32
0650	62
0651	32
0652	18
0653	20
0654	3
0655	1
0656	4
0657	114
0658	119
0659	39
0660	34
0661	9
0662	9
0663	71
0664	33
0665	1
0666	4
0667	71
0668	154
0669	153
0670	19
0671	92
0672	27
0673	100
0674	5
0675	48
0676	133
0677	164
0678	03-A
0680	
0681	4
0682	7
0683	
0684	24
0685	n/a
0686	90.00

Low Manhole Per Pump Station Basin	
Pump Station #	Low Manhole #
0687	27
0688	107
0689	4
0690	4
0691	
0693	26
0694	45
0695	7
0696	37
0697	5
0699	44
0700	2
0701	62
0702	2
0703	14
0704	95
0705	41
0706	95
0707	75
0708	54
0709	52
0710	55
0711	102
0712	2
0713	19
0714	43
0715	20
0717	3
0718	18
0719	18
0720	6
0721	n/a
0722	24
0723	29
0724	11
0725	10
0726	4

Low Manhole Per Pump Station Basin	
Pump Station #	Low Manhole #
0727	N/A
0728	102
0729	4
0730	4
0731	n/a
0732	23
0733	n/a
0734	13
0735	3
0736	3
0737	7
0738	5
0739	9
0740	14
0741	9
0742	29
0743	10
0744	1
0745	25
0746	n/a
0747	1
0748	7
0749	4
0750	1
0751	2
0752	4
0753	39
0754	
0755	338
0756	n/a
0757	220
0758	2
0759	2
0760	11
0761	147
0762	14
0763	24

Low Manhole Per Pump Station Basin	
Pump Station #	Low Manhole #
0764	n/a
0765	1
0766	31
0767	25
0768	17
0769	15
0770	21
0771	6
0772	52
0773	25
0774	32
0775	22
0776	16
0777	7
0778	3
0779	12
0780	7
0781	10
0782	40
0783	11
0784	3
0785	83
0786	1
0787	11
0788	n/a
0789	6
0790	24
0791	41
0792	16
0793	16
0794	28
0795	23
0796	4
0797	4
0798	29
0799	6
0800	21

Low Manhole Per Pump Station Basin	
Pump Station #	Low Manhole #
0801	2
0802	31
0803	13
0804	n/a
0805	18
0806	136
0807	44
0808	12
0809	55
0810	9
0811	31
0812	2
0813	7
0814	3
0815	50
0816	13
0817	1
0818	24
0819	7
0820	1
0821	11
0822	40
0823	21
0824	54
0825	10
0826	10
0827	19
0828	10
0829	17
0830	51
0831	45
0832	12
0833	4
0834	7
0835	17
0836	1
0837	26

Low Manhole Per Pump Station Basin	
Pump Station #	Low Manhole #
0838	53
0839	22
0840	19
0841	22
0842	21
0843	29
0844	38
0845	16
0846	15
0847	2
0848	30
0849	1
0850	61
0851	7
0852	7
0853	44
0854	14
0855	5
0856	22
0857	53
0858	64
0859	1
0860	16
0861	1
0862	26
0863	13
0864	16
0865	27
0866	38
0867	8
0868	51
0869	34
0870	1
0871	78
0872	6
0873	14
0874	78

Low Manhole Per Pump Station Basin	
Pump Station #	Low Manhole #
0875	30
0876	17
0877	34
0878	5
0879	74
0880	2
0881	27
0882	18
0883	20
0884	n/a
0885	9
0886	024A
0887	49
0888	88
0889	1
0890	19
0891	16
0892	127
0893	6
0894	82
0895	2
0896	
0897	5
0898	49
0899	1
0947	58
0951	n.a
0952	0
1000	63
1001	25
1002	42
1003	11
1004	13
1005	3
1006	0
1007	207
1008	17

Low Manhole Per Pump Station Basin	
Pump Station #	Low Manhole #
1009	49
1010	15
1011	8
1012	1
1013	43
1014	2
1015	2
1016	86
1017	119
1018	13
1019	48
1020	11
1021	101
1022	54
1023	50
1024	79
1025	32
1026	21
1027	17
1028	34
1029	67
1030	36
1031	4
1032	30
1033	37
1034	37
1035	16
1036	8
1037	3
1038	2
1039	16
1040	76
1041	11
1042	21
1043	15
1044	25
1045	5

Low Manhole Per Pump Station Basin	
Pump Station #	Low Manhole #
1046	44
1047	27
1048	46
1049	34
1051	52
1052	31
1053	8
1054	29
1055	9
1056	12
1057	4
1058	41
1059	56
1060	17
1061	4
1062	29
1063	47
1064	1
1065	19
1066	5
1067	33
1068	46
1069	3
1070	4
1071	11
1072	12
1073	n/a
1074	2
1075	5
1076	23
1077	16
1078	1
1079	30
1080	14
1081	23
1082	17
1083	35

Low Manhole Per Pump Station Basin	
Pump Station #	Low Manhole #
1084	18
1085	7
1086	28
1087	17
1088	35
1089	31
1090	54
1091	130
1092	18
1093	2
1094	43
1095	13
1096	n/a
1097	49
1098	
1099	42
1100	15
1101	51
1102	182
1103	35
1104	58
1105	7
1106	76
1107	16
1108	n/a
1109	n/a
1110	15
1111	
1113	n/a
1114	n/a
1115	n/a
1116	n/a
1117	
1118	n/a
1119	
1120	n/a
1121	n/a

Low Manhole Per Pump Station Basin	
Pump Station #	Low Manhole #
1122	No data
1123	No data
1124	n/a
1126	
1127	No data
1129	
1130	
1131	No data
1132	No data
1133	No data
1134	
1136	No data
1200	16
1201	39
1202	35
1203	
1204	1
1205	28
1206	14
1207	165
1208	n/a
1209	0
1210	0
1211	n/a
1212	
1213	
1214	n/a
1215	n/a
1216	No data
1217	
1218	
1220	n/a
1221	No data
1222	No data
1223	
1224	
1225	No data

Low Manhole Per Pump Station Basin	
Pump Station #	Low Manhole #
1226	n/a
1228	No data
1251	No data
1252	No data
1300	29
1301	17
1302	17
1303	45
1304	8
1305	78
1306	15
1307	24
1309	6
1311	54
1312	14
1313	64
1314	
1315	n/a
1316	0
1317	0
1318	
1319	
1321	
1322	
1323	
9938	n/a
9940	n/a
9941	No access
9942	No access
9946	n/a
9948	

THIS PAGE LEFT INTENTIONALLY BLANK



# APPENDIX F

## Sewage Backup Prevention Fact Sheet

THIS PAGE LEFT INTENTIONALLY BLANK



# Sewage Backup Prevention

## What is a Sewage Backup?

Accumulation of fats, oil and grease and root intrusion in both private and public sewer lines are major reasons for backups. Also, flushing items down the toilet that are too large for sewer lines to handle – such as toys and sanitary napkins – can cause backups.

## What to Do After a Sewage Backup

- **Safety First**
- Standing water in your building can be dangerous. Do not enter the area if the water level has reached any electrical connection, extension cord or electrical outlet.
- **Turn Off Power Supply**  
When in doubt, turn off the power supply to the affected area of your home or office building. Turn off the gas to your hot water heater.
- **Call Miami-Dade Water and Sewer Department (WASD)**  
(305) 274-9272 WASD will send a maintenance crew to determine the cause of the backup.

## Understanding WASD Regulations

If your toilet isn't flushing properly, STOP FLUSHING. More water causes a bigger mess.

- **Customer Responsibilities:** You are responsible for maintenance of the plumbing from the connection at the service lateral into and including the house plumbing. You are also responsible for keeping the lateral free from obstructions.
- **WASD Responsibilities:** WASD does not charge for problems due to obstructions in the sewer main or due to failure of the service lateral. WASD reimburses all reasonable plumbers' fees and takes corrective action if the plumber correctly determines it is a WASD problem.
- **WASD Limitations:** WASD encourages you to call a professional (i.e., a plumber) prior to calling the department. If the #2 clean out at the edge of the property is unavailable for inspection, WASD can only check to ensure the sewer main (in the street) is in order. If this is functioning properly, you will be billed for a service call and you will still need to contact a plumber to help you.

## Cleanup and Disinfection

WASD's cleanup contractor cleans and disinfects your home if our investigators determine WASD caused a sewer backup. If you refuse this WASD-paid service and decide to cleanup on your own, you are responsible for the incurred costs.

Touching or walking through contaminated areas can bring germs into uncontaminated areas of your home.

## To Prevent Backups

The majority of sewer backups into homes or buildings are not caused by a failure of the public sewer system, but rather an issue with the private plumbing system. Regardless of cause, building backups are most likely to occur during heavy rainfall. Here are simple things you can do to help prevent them.

- **DO:** Collect grease in a container and dispose of it in the garbage.
- **DO:** Place food scraps in the garbage.
- **DO:** Place a wastebasket in the bathroom to dispose of solid waste, feminine products and "flushable wipes."
- **DO NOT** pour fats, oils, and grease down the drain.
- **DO NOT** use the sink to dispose of food scraps.
- **DO NOT** put "flushable wipe" products or feminine hygiene products down the toilet.
- **DO NOT** use the toilet as a wastebasket for garbage and chemicals.

QUALITY. VALUE. ECONOMIC GROWTH.

[WWW.MIAMIDADE.GOV/WATER](http://WWW.MIAMIDADE.GOV/WATER)



## Cleanup and Disinfection Tips

- Don't stand in water or sewage.
- Using disposable gloves, place objects that have come in contact with sewage into plastic bags for disposal.
- Wash the affected area with steam or hot water.
- Spray chlorine bleach or other germicidal cleaner throughout the affected area; let it react for 10 minutes before rinsing with water.
- Remove and dispose of the sections of flooring that cannot be salvaged by cleaning and disinfection.

FOR MORE INFORMATION

**Juan Bedoya**  
Assistant W&S Superintendent  
786-268-5026  
jbedo@miamidade.gov

**Adriana Lamar**  
Chief, Public and Governmental Affairs  
786-552-8087  
alamar@miamidade.gov



# Prevención de Desbordamientos Sanitarios

## ¿Que son los desbordamientos sanitarios y cómo se ocasionan?

Los desbordamientos sanitarios son derrames de aguas negras (o aguas servidas) procedentes de los alcantarillados. Los desbordamientos son ocasionados por obstrucciones en las tuberías causadas por la acumulación de grasas y aceites, la intrusión de raíces, o al descargar objetos muy grandes por el inodoro como juguetes, pañales, papel toalla, etc.

## ¿Qué debe hacer si ocurre un desbordamiento?

- **Su seguridad ante todo:** No entre al área afectada si nota que el nivel del agua estancada alcanza algún cable o conexión eléctrica.
- **Desconecte la electricidad.** Si no está seguro del alcance del derrame, desconecte la alimentación eléctrica a toda la zona afectada del edificio, y cierre la alimentación de gas al calentador de agua.
- **Llame al Departamento de Agua y Alcantarillado de Miami-Dade (WASD)** al (305) 274-9272. WASD enviará a personal de mantenimiento para determinar la causa del desbordamiento.

## Entienda Las Regulaciones de WASD

Si el inodoro no está vaciando NO LO VUELVA A DESCARGAR. Esto creará un problema más grande.

- **Responsabilidades del Cliente:** Usted es responsable por el mantenimiento de las tuberías sanitarias desde la conexión al lateral de servicio, e incluyendo las tuberías internas a su casa.
- **Responsabilidades de WASD:** Si se determina que WASD es responsable por el desbordamiento en su propiedad, WASD se encargará de destupir la tubería y de realizar los trabajos de limpieza y desinfección en su propiedad libre de costos. WASD reembolsará al cliente por todos los gastos de plomería justos y razonables, y tomará las medidas adicionales necesarias para corregir el problema.
- **Limitaciones de WASD:** Contacte a un plomero antes de llamar a WASD para determinar la causa del problema. Si reporta el problema a WASD y luego se determina que la obstrucción no está ubicada en la sección pública del sistema de alcantarillado, WASD no tomará mayor acción y le cobrará por la visita. Usted todavía será responsable de contactar un plomero para destupir su tubería. Asegúrese que tenga disponible para la inspección su caja de servicio del cliente (conocido como cleanout #2).

## Limpieza y Desinfección

La empresa de limpieza contratada por WASD limpiará y desinfectará el área afectada si los investigadores de WASD determinan que WASD es responsable por el derrame en su propiedad. Si decide no aceptar este servicio pagado por WASD y quiere realizar la limpieza por su propia cuenta, usted será responsable por estos costos. Caminar o tocar las áreas contaminadas puede transmitir gérmenes a otras áreas de su casa.

## Como Prevenir Desbordamientos

La mayoría de los desbordamientos en propiedad privada no son causados por fallas en la red de alcantarillado pública, sino debido a problemas en las tuberías residenciales. Los desbordamientos están más propensos a ocurrir durante fuertes lluvias. Aquí hay algunas medidas preventivas que pueden ayudar a prevenir los desbordamientos en su propiedad:

- **Colecte** el aceite en envases vacíos y deséchelos en la basura
- **NO** vierta las grasas o aceites por el fregadero
- **Deseche** los restos de comida en la basura
- **NO** deseche los restos de comida por el fregadero
- **Coloque** los desechos sólidos del baño en una cesta de basura, (pañales, productos de higiene femenina, toallas húmedas, etc.)
- **NO** deseche las toallas húmedas, o productos de higiene femenina por el inodoro.
- **NO** utilice el inodoro como basurero de costumbre para objetos sólidos o químicos

QUALITY. VALUE. ECONOMIC GROWTH.

WWW.MIAMIDADE.GOV/WATER



## Limpieza y Desinfección

- No camine por áreas de agua estancada
- Utilizando guantes desechables, coloque aquellos objetos que hayan estado en contacto con las aguas negras en bolsas de plástico para luego ser desechadas.
- Limpie el área afectada con vapor o agua caliente
- Rocíe cloro (límpido) u otro limpiador antibacterial por las áreas afectadas y déjelo actuar por 10 minutos antes de enjuagar con agua.
- Remueva y deseche la porción de la alfombra o el piso de madera que estuvo en contacto con las aguas negras y que no se pueda salvar.

**PARA MAS INFORMACION**

**Juan Bedoya**  
Assistant W&S Superintendent  
786-268-5026  
jbedo@miamidade.gov

**Adriana Lamar**  
Chief, Public and Governmental Affairs  
786-552-8087  
alamar@miamidade.gov

# APPENDIX G

## Orifice Tables for SSO Discharge Volume Calculations

THIS PAGE LEFT INTENTIONALLY BLANK

# DISCHARGE IN GALLONS PER MINUTE FOR ROUNDED HOLES

Hole Size (in inches)	0.5	0.75	1	1.5	2	3	4	5	6	7	8	9	10	11	12	13	14
Hole Area (in sq. ft)	0.001	0.003	0.005	0.012	0.022	0.049	0.087	0.136	0.196	0.267	0.349	0.442	0.545	0.660	0.785	0.921	1.068

Pressure (psi)	Q																				
	2	4	6	8	10	12	14	16	18	20	22	24	26	28	30	32	34	36	38	40	
2	10	23	41	93	165	372	662	1034	1489	2027	2647	3350	4136	5005	5956	6990	8107				
4	15	33	58	132	234	526	936	1462	2106	2866	3743	4738	5849	7077	8423	9885	11464				
6	18	40	72	161	287	645	1146	1791	2579	3510	4585	5803	7164	8668	10316	12107	14041				
8	21	47	83	186	331	744	1324	2068	2978	4053	5294	6700	8272	10009	11912	13980	16213				
10	23	52	92	208	370	832	1480	2312	3329	4532	5919	7491	9248	11190	13318	15630	18127				
12	25	57	101	228	405	912	1621	2533	3647	4964	6484	8206	10131	12259	14589	17121	19857				
14	27	62	109	246	438	985	1751	2736	3939	5362	7003	8864	10943	13241	15758	18493	21448				
16	29	66	117	263	468	1053	1872	2925	4211	5732	7487	9476	11698	14155	16846	19770	22929				
18	31	70	124	279	496	1117	1985	3102	4467	6080	7941	10050	12408	15014	17867	20969	24320				
20	33	74	131	294	523	1177	2093	3270	4708	6409	8371	10594	13079	15826	18834	22104	25635				
22	34	77	137	309	549	1235	2195	3429	4938	6722	8779	11111	13718	16598	19753	23183	26886				
24	36	81	143	322	573	1289	2292	3582	5158	7020	9170	11605	14327	17336	20632	24213	28082				
26	37	84	149	336	597	1342	2386	3728	5369	7307	9544	12079	14913	18044	21474	25202	29229				
28	39	87	155	348	619	1393	2476	3869	5571	7583	9904	12535	15475	18725	22285	26153	30332				
30	40	90	160	360	641	1442	2563	4005	5767	7849	10252	12975	16019	19383	23067	27071	31396				
32	41	93	165	372	662	1489	2647	4136	5956	8107	10588	13401	16544	20018	23823	27959	32426				
34	43	96	171	384	682	1535	2728	4263	6139	8356	10914	13813	17053	20634	24556	28820	33424				
36	44	99	175	395	702	1579	2808	4387	6317	8598	11230	14213	17548	21232	25268	29655	34393				
38	45	101	180	406	721	1623	2885	4507	6490	8834	11538	14603	18028	21814	25961	30468	35336				
40	46	104	185	416	740	1665	2959	4624	6659	9063	11838	14982	18497	22381	26635	31259	36254				

# DISCHARGE IN GALLONS PER MINUTE FOR ROUNDED HOLES

Hole Size (in inches)	15	16	17	18	19	20	21	22	23	24	25	26	27	28	29	30	31
Hole Area (in sq. ft)	1.227	1.396	1.575	1.766	1.968	2.181	2.404	2.638	2.884	3.140	3.407	3.685	3.974	4.274	4.585	4.906	5.239

Pressure (psi)	Q																
	2	9306	10588	11953	13401	14931	16544	18240	20018	21879	23823	25850	27959	30151	32426	34784	37224
4	13161	14974	16904	18951	21115	23397	25795	28310	30942	33691	36557	39540	42640	45857	49191	52643	56210
6	16118	18339	20703	23211	25861	28655	31592	34672	37896	41263	44773	48427	52224	56164	60247	64474	68844
8	18612	21176	23906	26801	29862	33088	36479	40036	43759	47647	51700	55919	60303	64852	69567	74448	79494
10	20809	23676	26728	29965	33387	36993	40785	44762	48924	53270	57802	62519	67420	72507	77779	83235	88877
12	22795	25936	29279	32825	36573	40524	44678	49034	53593	58355	63319	68486	73855	79427	85202	91179	97359
14	24621	28014	31625	35455	39503	43771	48258	52963	57887	63030	68392	73973	79773	85791	92029	98485	105160
16	26321	29948	33808	37903	42231	46793	51590	56620	61884	67382	73115	79081	85281	91715	98383	105285	112421
18	27918	31764	35859	40202	44793	49632	54719	60055	65638	71470	77550	83878	90454	97278	104351	111672	119240
20	29428	33483	37799	42376	47216	52317	57679	63303	69189	75336	81745	88415	95347	102540	109996	117712	125690
22	30864	35117	39644	44445	49520	54870	60494	66393	72566	79013	85734	92730	100001	107545	115364	123458	131825
24	32237	36678	41406	46421	51722	57310	63184	69345	75792	82526	89547	96854	104447	112327	120494	128947	137687
26	33553	38176	43097	48317	53834	59650	65764	72177	78887	85896	93203	100809	108712	116914	125414	134213	143309
28	34820	39617	44724	50140	55866	61902	68247	74901	81865	89139	96722	104614	112816	121327	130148	139279	148719
30	36042	41008	46294	51900	57827	64074	70642	77530	84738	92267	100116	108286	116776	125586	134716	144167	153939
32	37224	42352	47812	53602	59724	66176	72959	80073	87517	95293	103400	111837	120605	129705	139135	148895	158987
34	38369	43656	49283	55252	61562	68212	75204	82537	90211	98226	106582	115279	124317	133696	143417	153478	163880
36	39482	44922	50712	56854	63346	70190	77384	84930	92826	101074	109672	118621	127921	137572	147574	157928	168631
38	40564	46153	52102	58412	65082	72113	79505	87257	95370	103843	112677	121872	131427	141342	151618	162255	173252
40	41618	47352	53455	59929	66773	73987	81570	89524	97847	106541	115604	125038	134841	145014	155557	166470	177753



# DISCHARGE IN GALLONS PER MINUTE FOR ROUNDED HOLES

Hole Size (in inches)	32	33	34	35	36	37	38	39	40	41	42	43	44	45	46	47	48
Hole Area (in sq. ft)	5.582	5.937	6.302	6.678	7.065	7.463	7.872	8.292	8.722	9.164	9.616	10.080	10.554	11.039	11.535	12.042	12.560

Pressure (psi)	Q																
	2	42352	45041	47812	50666	53602	56622	59724	62908	66176	69526	72959	76474	80073	83754	87517	91364
4	59895	63697	67616	71652	75805	80075	84462	88966	93587	98325	103179	108151	113240	118446	123768	129208	134765
6	73357	78013	82813	87756	92842	98072	103444	108960	114620	120422	126368	132458	138690	145066	151585	158247	165053
8	84705	90082	95624	101332	107205	113243	119447	125817	132352	139052	145918	152949	160145	167507	175035	182728	190586
10	94703	100714	106911	113292	119859	126610	133546	140667	147974	155465	163141	171002	179048	187279	195695	204296	213082
12	103742	110327	117115	124105	131298	138694	146292	154093	162097	170303	178712	187323	196137	205154	214373	223795	233420
14	112054	119167	126499	134049	141819	149807	158014	166440	175085	183948	193031	202332	211852	221591	231549	241726	252122
16	119791	127395	135233	143305	151610	160150	168924	177932	187173	196649	206359	216302	226480	236891	247537	258416	269530
18	127057	135123	143436	151997	160807	169865	179171	188725	198527	208578	218876	229423	240218	251261	262552	274092	285879
20	133930	142432	151195	160219	169506	179053	188863	198934	209266	219860	230716	241833	253212	264852	276755	288918	301343
22	140467	149384	158574	168040	177779	187793	198081	208643	219480	230591	241977	253637	265571	277780	290263	303020	316052
24	146713	156026	165626	175512	185684	196143	206889	217921	229240	240845	252737	264915	277380	290131	303169	316494	330105
26	152704	162397	172389	182678	193266	204152	215337	226819	238600	250679	263057	275732	288706	301978	315549	329417	343584
28	158469	168528	178896	189574	200562	211859	223465	235381	247607	260142	272987	286141	299605	313378	327460	341853	356554
30	164031	174443	185175	196228	207601	219295	231309	243643	256298	269273	282568	296184	310120	324377	338954	353851	369069
32	169410	180164	191248	202663	214410	226487	238895	251633	264703	278104	291835	305898	320291	335015	350070	365456	381172
34	174624	185708	197134	208901	221008	233457	246247	259378	272850	286663	300817	315312	330148	345325	360844	376703	392904
36	179686	191092	202849	214957	227416	240225	253386	266898	280760	294974	309538	324453	339720	355337	371305	387624	404294
38	184610	196329	208408	220847	233647	246808	260329	274211	288454	303056	318020	333344	349029	365074	381480	398246	415373
40	189406	201429	213822	226584	239717	253220	267092	281335	295947	310929	326282	342004	358096	374558	391390	408592	426164

THIS PAGE LEFT INTENTIONALLY BLANK

